



柏楚电子
Friendess Co., Ltd.

Friendess CypCut Laser Cutting Control System

User Manual

Version 6.5



Welcome

Thank you for using CypCut laser cutting control system!

CypCut laser cutting control software is designed for plane sheet machining that supports editing cutting technique, nesting parts and controlling machining process. Main functions include graphics processing, parameter setting, cutting process customization, parts nesting, tool path planning and simulation, and cutting process control.

Only when use with encryption dog and control card can CypCut realize machining control.

CypCut will enter the demo mode when running on a computer without encryption dog and control card. Users can execute all functions except real machining control. Therefore, users can install CypCut on a laptop for pre-machining design.

Please note that this manual is only the operation instructions for the main program of CypCut. For other programs installed with CypCut including config tool please refer to related manual or contact with us directly.

This document is based on CypCut 6.3.731. Due to continuous updating of program functions, the CypCut you use may differ in some respects from the statement in this manual.

If you have any question or advice in usage of our products, welcome to contact us.



The working and cutting performance of the machine are directly related to the material, laser, cutting gas, gas pressure and the parameters setup. Please be cautious in setting the parameters!

Improper parameter setting and operation may reduce the cutting performance, or even cause damage to machine parts and human body. CypCut system has already provided multiple protections, meanwhile manufactures and users must follow the safety operation rules in case of any accidents and injuries.

Shanghai Friendess Electronic Technology Corporation Limited does not bear any direct, indirect, incidental or corresponding losses and liabilities arising from the improper use of this manual or this product.



Contents

Welcome	1
Contents	3
1. Quick start	7
1.1 Function Features	7
1.2 Access, Upgrade and Install Software	8
1.3 Start Operation.....	9
1.3.1 Desktop Shortcut.....	9
1.3.2 User interface	9
1.3.3 Toolbar	11
1.3.4 File Menu.....	12
1.4 Operation Process.....	13
1.4.1 Import File	14
1.4.2 Pre-Processing.....	14
1.4.3 Cutting Technique	15
1.4.4 Cutting Path Planning	16
1.4.5 Pre-Machining Check	16
1.4.6 Start Machining.....	17
2. Graphic Edit	19
2.1 Graphic Display	19
2.2 Selection.....	20
2.3 Geometric Transform	21
2.3.1 Size Modification	21
2.3.2 Dynamic Transform	22
2.3.3 Translation and Copy	23
2.4 Coordinate and Parameter Input.....	23
2.5 Automatic Adsorption	24
2.6 Graphic Drawing	24
2.6.1 Standard Graphic Drawing	25
2.6.2 Text Input.....	25
2.6.3 Standard Parts.....	26
2.7 Measure	26
2.8 Graphic Optimization.....	26



2.8.1	Smooth	27
2.8.2	Split	27
2.8.3	Remove Trivial	28
2.8.4	Remove Duplication	28
2.8.5	Combine Near.....	28
2.8.6	Chop	28
2.8.7	Plate Separate	29
2.9	View	29
2.9.1	Node Edit	29
3.	Graphic Technique and Tools.....	31
3.1	Lead Line	31
3.1.1	Distinguish Inner and Outer Contour.....	31
3.1.2	Automatic Lead Line.....	32
3.1.3	Manual-set Lead Line	33
3.1.4	Check Lead Line	33
3.1.5	Overcut, Gap, Seal and Multi-cut	34
3.2	Seam Compensation.....	34
3.3	Micro-joint.....	35
3.4	Cooling Point	36
3.5	Ring Cut	37
3.6	Fillet/Release	38
3.7	Group.....	39
3.7.1	Sorting of Group	40
3.7.2	Machining of Group.....	40
3.8	Flying Cut	40
3.9	Co-edge	43
3.9.1	Automatic Absorb.....	43
3.9.2	Co-edge with Compensation	44
3.10	Bridge.....	44
3.11	Array	45
3.11.1	Rectangular Array	45
3.11.2	Manual Array.....	46
3.11.3	Circular Array.....	46
3.11.4	Full Fill	47
3.12	Quantity Modify	47
3.13	Cutting technique	49
3.13.1	Parametric Description	50



3.13.2	Real-time Power/Frequency Regulate	53
3.13.3	Layer Mapping	54
3.13.4	Lead Line Technique.....	54
3.14	Nest.....	56
3.14.1	Nesting	56
3.14.2	Nesting Report.....	59
3.14.3	File Switch.....	61
3.15	Sorting and Path Planning.....	61
3.15.1	Sequence Preview	62
3.15.2	Manual Sorting.....	62
3.15.3	Group Sorting	63
4.	Machining control.....	64
4.1	Coordinate System	64
4.1.1	Mechanical Coordinate System.....	64
4.1.2	Program Coordinate System.....	65
4.1.3	Find Zero Point after Interruption	65
4.2	Alarm.....	66
4.3	Manual Test.....	68
4.4	Soft Limit Protection.....	69
4.5	Frame.....	69
4.6	Start and Dry Run.....	69
4.7	Stop, Pause and Continue	71
4.8	Breakpoint.....	71
4.9	Start at Specified Position.....	72
4.10	Global Parameter	72
5.	CNC Assistant Function	75
5.1	Simulation	75
5.2	Find Edge	75
5.2.1	BCS100 Find Edge (Open in Platform Configuration Tool)	75
5.2.2	Infrared find edge (photoelectric sensor, open in platform configuration tool)	77
5.2.3	Cut Off (open in platform configuration tool).....	79
5.3	PLC Process.....	80
5.4	Return Origin Point	80
5.4.1	Return to Mechanical Origin	80
5.4.2	Gantry Synchronization	80
5.5	Optical Path Setting.....	81



5.6	Diagnosis Window	81
5.7	BCS100	82
5.8	QCW	82
5.9	Measure Deviation	83
5.10	Clean Nozzle (open in config tool)	83
6.	Appendix	85
6.1	Co-edge Example	85
6.2	Gantry Synchronization	87
	6.2.1 Platform Configuration	88
	6.2.2 Gantry Initialization and Synchronization	89
	6.2.3 Notice	90
6.3	BCS100 Find Edge Instructions	90
	6.3.1 Platform Configuration	90
	6.3.2 Single Point Find Edge	91
	6.3.3 Three-Point Find Edge	92
	6.3.4 BCS100 Find Edge Notices	92
6.4	Infrared Find Edge	93
	6.4.1 Photoelectric Switch	93
	6.4.2 Wiring and Configuration	94
	6.4.3 Three-point Find Edge	95
	6.4.4 Precautions	95
6.5	Regional Output	96
6.6	Motion Parameter Adjustment	97
	6.6.1 Motion Control Parameter	97
	6.6.2 Cut Acceleration	98
	6.6.3 Move Acceleration	98
	6.6.4 Low Pass Frequency	99
	6.6.5 Arc and Corner Precision	100
6.7	Shortcut Key	100
6.8	Burn Test	101



1. Quick start

1.1 Function Features

- ❑ Support AI, DXF, PLT, Gerber, LXD file format, and standard G code created by Master Cam, Type3, ARTCUT etc.
- ❑ Support file optimization includes: remove duplicates, connect unclosed segments, remove minimal graphic and distinguish inner and outer contour and set machining sequence automatically. Above functions can be customized or executed manually.
- ❑ Support graphic edit functions, including zooming, translation, mirror, rotation, alignment, replication, combination, etc.
- ❑ Support set lead line, cut seam compensation, micro-joint, bridge, inner/outer cut, seal etc.
- ❑ Automatically distinguish inner and outer contour then determine the compensation direction and check the lead line.
- ❑ Support curve split, merge and smooth; transfer text to curve; parts combination and explode etc.
- ❑ Automatic nesting can create co-edge and remnant plate.
- ❑ Users can fill the plate by array function.
- ❑ Flexible sorting functions. Users can group the graphics to lock the cutting sequence.
- ❑ Preview the cutting sequence.
- ❑ Quick set fly cut path.
- ❑ Support various piercing methods including segmented pierce, incremental pierce, pre-pierce, group pre-pierce. Users can also set separate parameters of pierce and cutting including laser power, frequency, gas, pressure, peak power, delay, cut height etc.
- ❑ Real-time frequency and power curve editing. Set slow start parameters.



- ❑ Powerful material library function allows all process parameters to be saved for reuse of the same material.
- ❑ Breakpoint memory when machining interrupted. And users can select resume position before or after breakpoint. Support machining selected graphic.
- ❑ Users can locate to specified position in stop or pause status and resume machining.
- ❑ Support round tube and plane sheet cutting; Support intersecting line cutting.
- ❑ Support cutting at fixed height and laser head follows in from outside plate.¹
- ❑ Support various find edge methods with high precision.
- ❑ Powerful expansion capacity with 30 PLC, more than 50 programmable processes.²
- ❑ Support programmable input and output port, and alarm input 2.
- ❑ Support remote control of the system through wireless operator and ethernet.³

1.2 Access, Upgrade and Install Software

You can contact the supplier to get the software or directly download on Friendless company website www.fscut.com.

Before installation, check your system meets the following configuration requirements:

- ❑ Win7 and above operating system.
- ❑ CPU I3 and above.
- ❑ At least 4 GB memory.

¹This function requires BCS100 controller.

²This function requires trained professionals and password credential given by manufacture.

³Necessary hardware required.



- ❑ VGA display over 15 inches with resolution 1280*1024 is recommended.
32-bit true color display is recommended.
- ❑ At least 2 USB interfaces.
- ❑ If your operating system is based on Vista (including Windows Vista, Windows 7, Windows 8, Windows 2008 Server), try to run in administrator to avoid possible errors.

After checking the running environment you can directly install the software.

Under Vista-based operating systems it's required to run as administrator.

To avoid program files modified during installation and ensure all drivers installed properly, please close anti-virus software like 360 security guards.

Notice: 360 security guard cannot ensure that there is no virus on the computer. If the computer has been infected by the virus, and 360 security guard is running, it may prompt CypCut to be a virus, which may lead to CypCut cannot work properly.

1.3 Start Operation

1.3.1 Desktop Shortcut



After installation, the icon  will appear on the desktop. Double-click can run the CypCut laser cutting control software.

If you are using BMC1204 or BMC1205 PCI control card, please check whether the encryption dog has inserted into the USB port and running normally. If software dog detection failed software will enter into demo mode.

If you are using BMC16** and above control card (like BMC1604, BMC1605, BMC1805 card), the encryption dog has been built in the control card already no need separate dog.

1.3.2 User interface

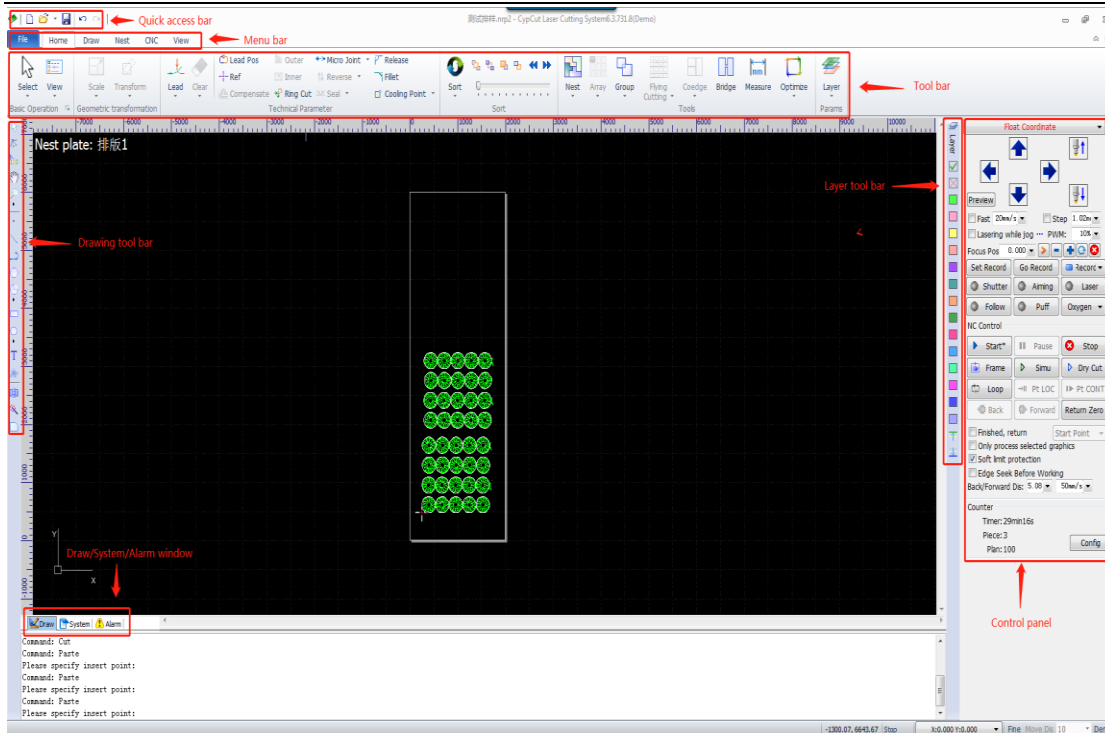

The center zone in black is **drawing board**, the white frame is the machine working area. The grid of drawing board and ruler will adjust when zoom the view.

On the main screen from top to bottom is **title bar**, **menu bar** and **tool bar**. You can find most commonly used functions in tool bar where the function button group displayed with clear icons. The menu bar includes 'File' menu and other 5 tool menus 'Home', 'Draw', 'Nest', 'CNC' and 'View'. Click the menu will display the related tool bar. At top left is "**Quick Access Bar**", which is used to create, open and save files. Also undo and redo the operation.

On left side is "**Drawing toolbar**"; the basic drawing functions are provided here. The first five buttons are used to switch the drawing mode, including selection, node editing, and sequence editing, dragging and zooming. The other buttons below correspond to the graphic, click to insert new graphic on drawing board. There are three keyboard shortcuts at the bottom, which are align center, explode graphic and add fillet.

On the right side is the "**Technique toolbar**" including 1 'layer' button and other 17 buttons of different layer color. Click 'Layer' button will open 'Cutting Technique' window where users can set most of the parameters related with material cutting; 17



buttons each corresponds with a layer click a button will appoint a layer to selected graphic; if no graphics selected, click layer color button next time you drawing a graphic will use it as default layer. Appoint first layer to a graphic, controller will define this graphic as 'background layer' and not machining. The last and second last layers are special, the graphics of these 2 layers will be cutting at last or at first. The second last layer usually used as marking layer.

There are three scrolling text ribbon windows at bottom. On the '**Draw**' window will display all information related with drawing command; On the '**System**' window will display all system information except drawing, each message printed with time line and marked with different color so users can recognize these message as error, alarm or notice etc. On the '**Alarm**' window displays all alarm messages of red color.

At the bottom is '**Status**' bar showing message according different operation. The left status bar shows graphic message, on the right side displays cursor position, machining status, laser head position. The rightmost is to fine tune the graphic position and displaying control card type.

On the right area of the main page is '**Control panel**' where users execute most commonly used machining operations. From top to bottom are coordinate system selection, manual control button, machining control, process setting and production counting.

1.3.3 Toolbar

CypCut tool bar displays as Ribbon style that partitions function buttons. The figure below will help you understand:

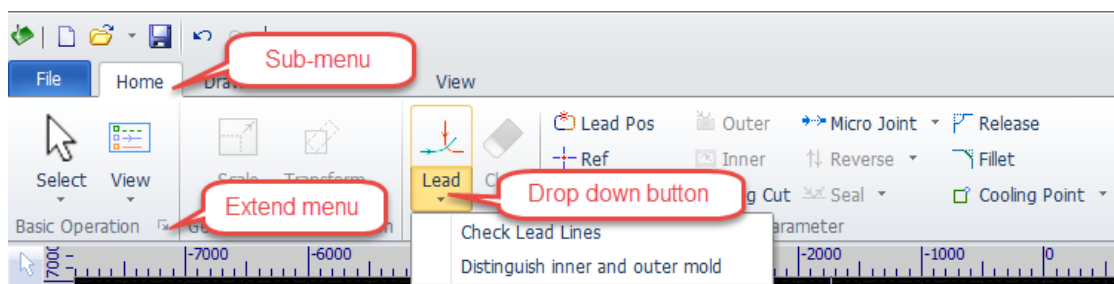



The toolbar is divided into five sub-menu 'Home', 'Draw', 'Nest', 'CNC', 'View'. Click sub-menu title will switch to the related page; in machining process will show 'Working' page and cannot switch to other page until process stops.

In each sub-menu there are function buttons divided into different region; the first button in each sub-menu usually in large size for convenient operation; Click icon '📄' will open a dialog box.

The '▼' under function button is drop-down menu provide more operation options. Click the icon and drop-down menu will open different dialog box with different options.

If you are Office 2007, Windows 7, or other ribbon-style programs user, you may already be familiar with this arrangement. Even you are first user will like the style.

1.3.4 File Menu

At top left is 'File Menu' contains options related with file operation click 'File' to open the menu:

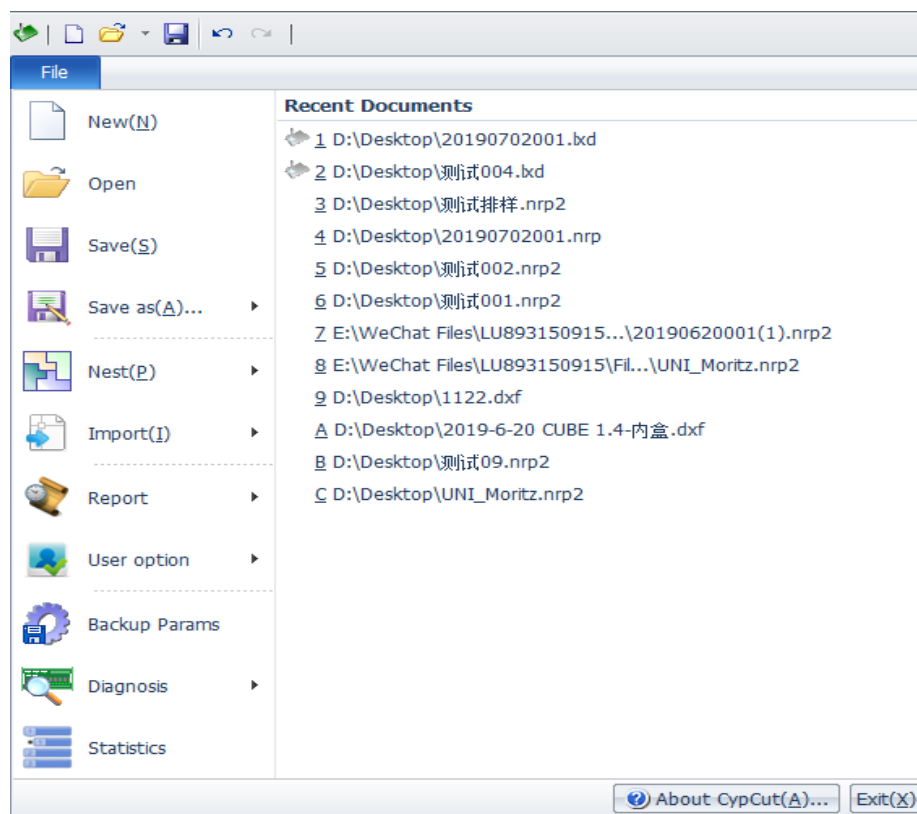



On the right column lists the recently opened file you can quickly find the needed file from the list.

Click 'save as' will save the file as Lxd or Dxf format.

From 'File-Import' add file will not clear current graphic. If you just need to open a file just click File-open.

CypCut V712.6 and above can open the nrp and nrp2 file generated by CypNest software.

By 'File-Report' users can export the machining report, nesting report and machine running status report.

The menu "User parameters" is used to set some parameters to fit user habit; By 'Backup param' in file menu users can back up all parameter setting in a compressed file. By 'BCS100 Monitor' in file menu to monitor the BCS100 controller interface; 'Diagnosis' window in file menu is to monitor and troubleshoot program.

Click 'About' at bottom right in file menu you can check the CypCut software version information.

1.4 Operation Process

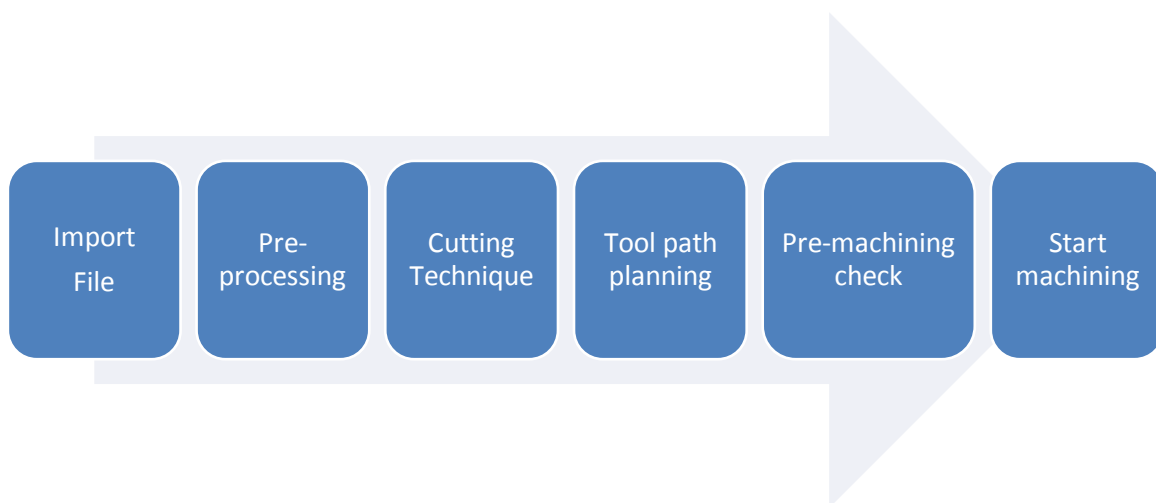



1.4.1 Import File

Click  button on the top left and select the file to open. Preview window of open file dialog box will help you quick locate the file you need.

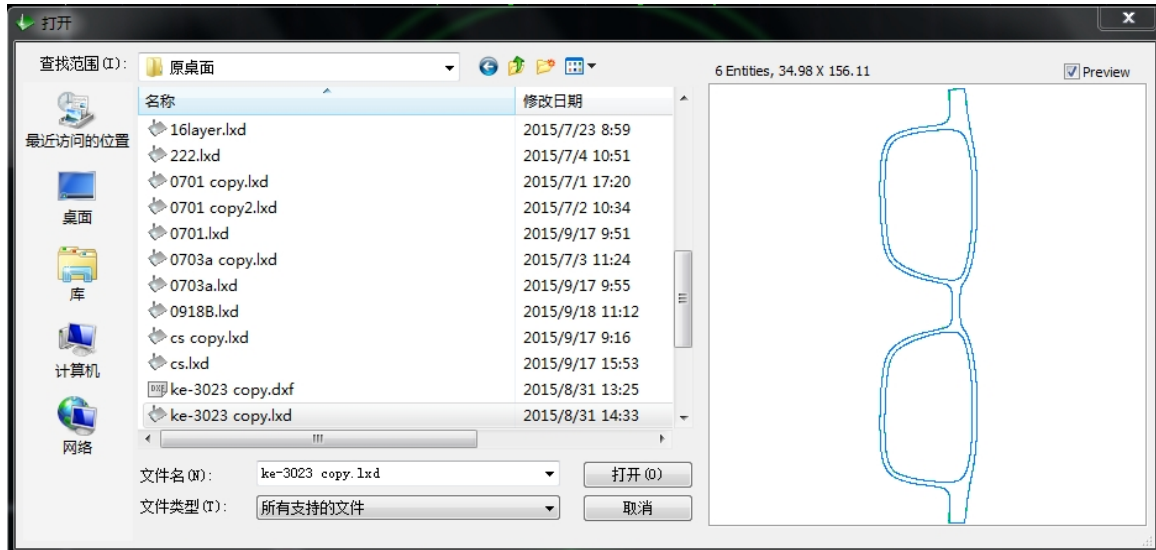



You can also draw a part in CypCut, click  and use functions at left toolbar.

1.4.2 Pre-Processing

While importing graphics, CypCut automatically removes minimal graphics and duplicate lines, merges unclosed lines, automatic smoothing and sorting. Generally, you can start to set cutting parameters without other operations. If the automatic processing cannot meet your requirements, you can open the menu "file" - "user parameters" to set the function options you need.

Generally, the software considers that all the graphics to be processed should be closed lines. If you open a file containing non-closed graphics, the software may prompt you message and display them in red color. This function may be turned off.

To view the unclosed graphics on the drawing board, you can click  and  under 'View' button in Home menu to highlight the unclosed graphics; you can also select unclosed graphics by clicking 'Select' and choose 'Select unclosed curve'.





If you need to split graphics manually, click  Split under "Optimize" drop down menu and click graphic where you want to split. To merge graphics, select the

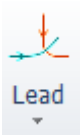
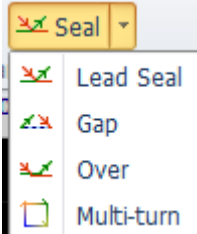

graphics you want to merge, and then click **Combine near** under 'optimize' drop down menu.

1.4.3 Cutting Technique

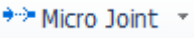
You may use most of the functions under "**Technical parameter**" column in the Home menu bar, including setting lead lines and compensation, etc. The large size

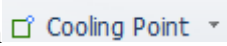
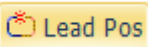
button  used to set lead lines, and the button  used to set the over-cut, gap or seal parameters. The button  is used to set compensation. The button  is used to set a micro-joint that will not be processed on the object. The button  is to reverse the machining direction of a single object selected. The button  is to set the cooling point. Click  button, then point on the graphic where you want the cutting to start at will set a start point. If you point outside graphic then point to the graphic will set a lead line.

You can press Ctrl+A select all graphic, click 'Lead' set parameters then program will set lead line automatically. Click 'Lead' drop-down menu select 'Check', program will check if lead line cross with graphic or in wrong direction and optimize the result.

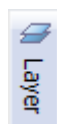

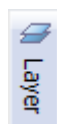

Click button  on the right toolbar to set the detailed cutting parameters. The layer parameters setting dialog box contains almost all the parameters related to the cutting performance.



1.4.4 Cutting Path Planning

Set the cutting sequence of graphic as needed. Click  in Home or Nest column will automatically set the cutting sequence of all graphic. Open drop-down menu you can choose sorting pattern, and recognize inner and outer contour of the parts graphic.

You can also choose Manual sort to optimize the auto-sort result by click  on left toolbar, then click the graphic to set the sequence. Click one graphic and click next will define the cutting sequence of these two graphics.



Select the graphics have been sorted (set sequence) and click  button in Home menu will set a group. The sequence of the graphics within a group will be fixed. And the group will be defined as a whole object.

Right click a group and select group sort you can modify the sequence of the graphics within a group.

1.4.5 Pre-Machining Check

Users can check the tool path before start machining. Click **Align** button will align the graphic; drag the **Progress bar** will quick show the graphic sequence; click **Interactive preview** button can check the sequence one by one.

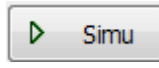

Click  button on console panel program will simulate the machining path and machine not running. Users can adjust simulation speed in  sub-menu.



1.4.6 Start Machining

Please take notice that it requires compatible control card and dongle to actually realize machining.

Before start machining it has to match the position of graphic and machine bed.

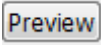
Click  button on the left side of the control panel will show the position of graphic on machine bed. This position is calculated by the reference mark location on the screen and the laser head position at machine. There are some symbols on the screen, click 'Preview' the 'Reference' mark will move to the laser head position.

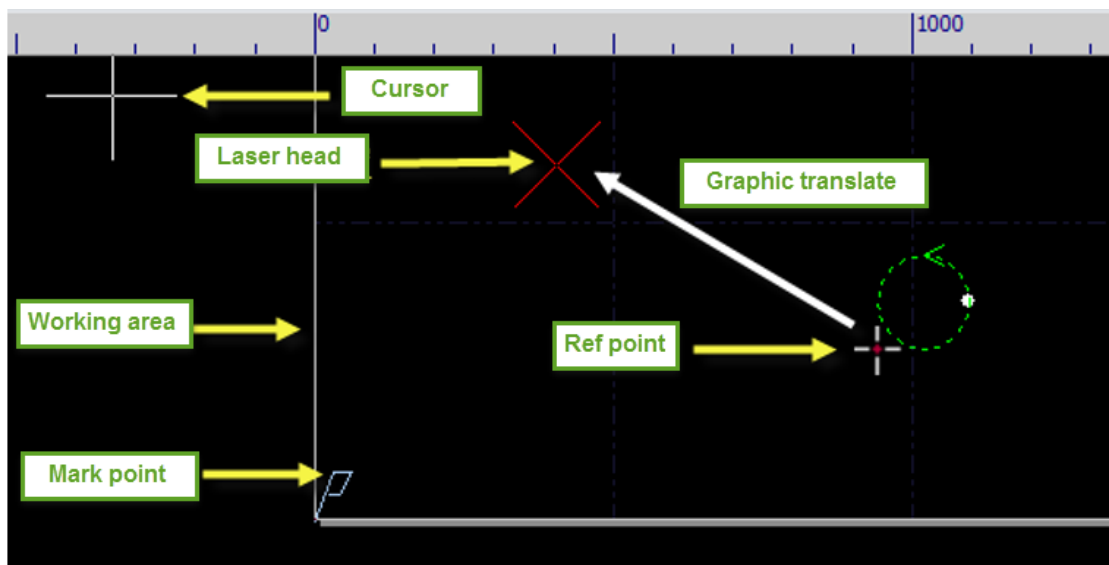

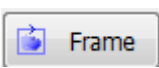

If the Red Cross does not match the real position of laser head, please check the mechanic origin and correct the origin by CNC-Return origin. If click 'Preview' and graphic is partly or fully outside the white frame, it means machine will exceed the travel range.

Click  in Home menu can modify the reference position of the graphic. For example, if laser head is at left bottom of the graphic then set the reference as left bottom.

After check the position, click  on control panel, laser head will move along the rectangular frame of the graphic, you can check if the machining area

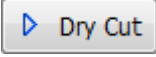

on machine bed is right. You can also click  to simulate the whole machining path on the machine bed without laser/gas to check if there is improper process.

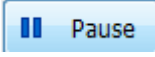
Click  start machining, Click  pause the process and you can manual control laser head up and down, open or close laser and gas etc.; In pause

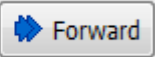
status users can click   to move forward or backward along

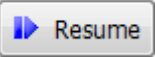
the graphic path. Click  resume the machining process.

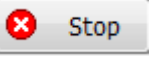
Click  end the machining process. Laser head will return to the pre-set position. If you didn't change graphic or start new machining process, click

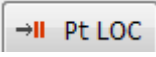
 will locate to the break position where last machining was end and click

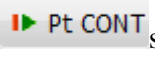
 start machining from break point.





2. Graphic Edit

2.1 Graphic Display

In Home menu -'View' column provides various options of graphic display.



Click the option button it will take effect immediately and you can see the display effect change on the screen. The option button shows in yellow indicates the option enabled. If the option button not in yellow color means function not enabled.

For example,  is enabled, graphic will show the cutting path with arrow symbol, close  the arrow symbol disappear.

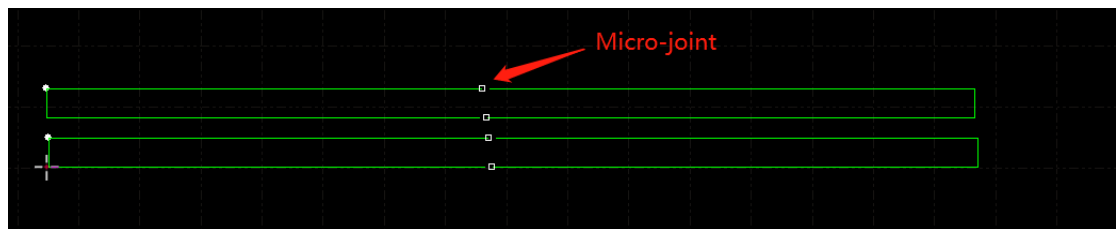
When 'Show Micons' opened, you can see the white mark at position where you add micro-joint:



When you click  Center the graphic will show in the center of the white frame.

Click  right down  button will open an option box providing detailed setting options where allow users to open or close graphic absorb function, ruler etc.

Scroll the mouse on the screen will zoom the view. Click F3 will center all graphic on the screen, click F4 will center the machine frame on the screen. Right click mouse will prompt option box, select zoom you can also execute same operations above.



2.2 Selection

CypCut provides various ways to select graphics. The basic operation is '**Click**', click the graphic will select it. Another commonly used operation is '**Frame**', drag the cursor on the screen will create a frame box. There are 2 patterns of 'Frame': Press and hold from left to right will create a blue box, only when a whole part was framed in the box will be selected. From right to left will create a green box, as long as part of the graphic was framed in the box, the whole graphic will be selected.

The 'frame' effect of these 2 patterns shown below. Left image is effect framing from left to right, 'BC' will be selected; right image is effect framing from right to left, 'ABCD' all selected. It's flexible to select graphic by these two patterns.



Press Shift when select graphic you can select or deselect graphic without changing the select result of other graphics.

Click 'Select' will open a drop down menu providing more options:

- ❑ Basic operations: Select all (Ctrl+A), Invert, Copy (Ctrl+C), Paste (Ctrl+V), Cut (Ctrl+X), Deselect, Copy with base point.
- ❑ Graphic operations: Select unclosed graphics, select similar graphics, select inner/outer contour, and select graphics smaller than specified size.
- ❑ Layer operations: Select the layer (used to select all the graphics in a layer) and lock the background.
- ❑ 'Disable Drag and Copy' will disable the operation that press Ctrl and drag the graphics to duplicate graphics. This will prevent the malposition of nested graphics.

'**Select similar graphic**' will select all graphics with same shape. For example, select a circle of 5mm radius, then click this option will select all circles of 5mm radius.



2.3 Geometric Transform

'Geometric Transform' under Home page provides abundant functions of transforming geometry including mirror, rotate, align and zoom etc.



2.3.1 Size Modification

CypCut provides 7 options under 'Scale' drop down menu to quick modify the graphic size. Pictured as right:

For example, '100mm' will zoom the width of graphic to 100mm in scale, '2 Times' will scale-up graphic 2 times in size.

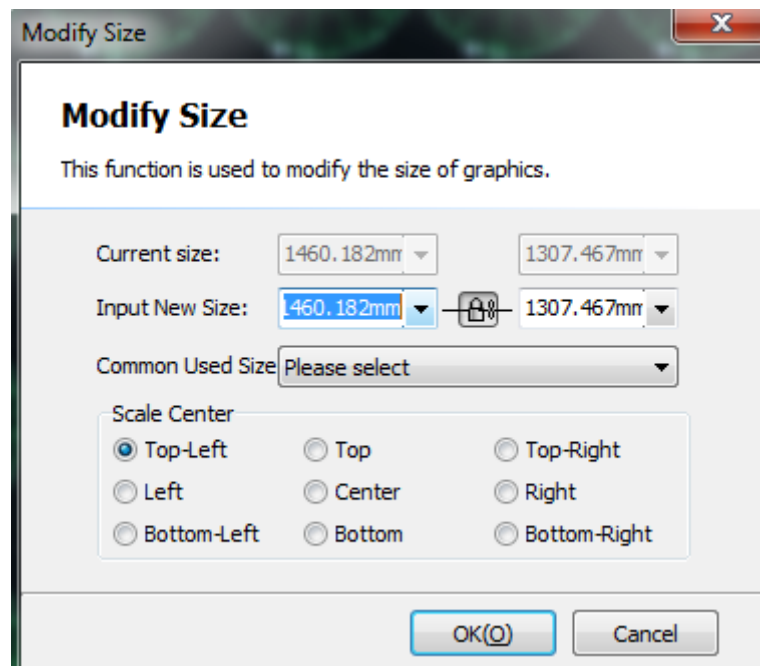
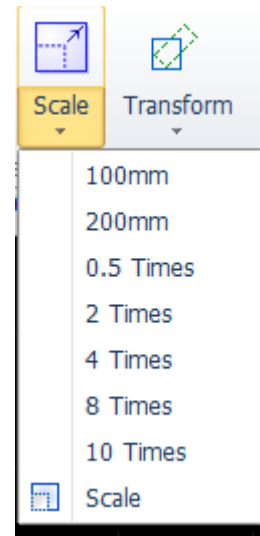
If you want to input an accurate dimension, click Scale button will prompt the below dialog box. Input new size and click Ok to finish the size modification.



If the lock icon in this state , the scale of length and width is coupled, if you want to modify the length and width separately click the icon  turn to state





"Scale center" specify the position between new graph and the original one. For example, "Top left" indicate the graph in new scale at the top left of the original one.

Notice: The lead lines and seam compensation etc., will not change with the size modification.

2.3.2 Dynamic Transform

CypCut provides 3 patterns of dynamic transform including dynamic scaling, rotating and mirror. First select the graphic and click transform button then follow operation tips at screen bottom.

For example, to rotate a rectangle 45° in the base line of left bottom, you can follow the operations:

- 1) Select graphic.
- 2) Click transform drop down menu select 'Rotate', at bottom window will prompt 'Please specify base point:'
- 3) Move cursor to the right corner, cursor will absorbed to the rectangle corner automatically:

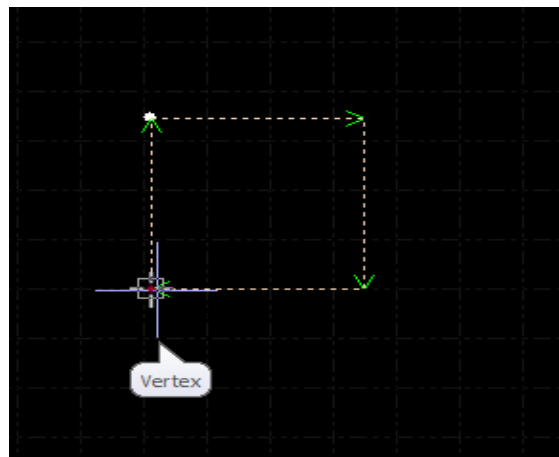

- 4) Click the corner, bottom window will prompt 'Please specify the start point or rotation angle:'
- 5) Input 45 and click Enter will finish the operation.

If you want to rotate the rectangle and align with another graphic, first step same with above, then follow the below steps:



- 6) Click the right corner of rectangle will create a base line.
- 7) Bottom window prompts 'Please specify end point of rotation' meanwhile move cursor graphic will rotate and click mouse at target position. As shown below:

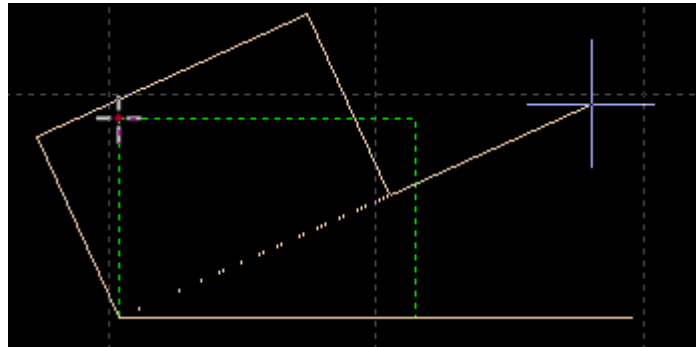

Dynamic mirror operation same with the rotate.

2.3.3 Translation and Copy

You can quick translate the graphic with direction button. First click

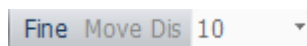

button at the right bottom of the screen to enable the function

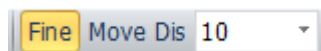

. Activate the button then you can input the fine tune

parameter. Select a graphic click the direction button it will move at this direction and in fine tune distance. This function used to move away a graphic temporarily and move back the graphic exactly where it was. Press Ctrl button and direction key in the same time will duplicate the graphic. For example, press 'Ctrl+right→' buttons will duplicate the selected graphic at the 100mm right side of the original one.

2.4 Coordinate and Parameter Input

In some cases, users need to draw graphic at an accurate coordinate. In CypCut users can input coordinates directly. Input format is < X coordinate><comma,><Y coordinate>. For example, the coordinates (100,100) input in CypCut is "100,100". The input coordinates and parameters are shown in blue.



Most of the drawing operations allow both mouse click a position and coordinate input. The following steps show you how to draw a rounded rectangle of length 300mm, width 200, fillet radius 25mm.

- 1) Click  button at left toolbar, meanwhile bottom window will prompt 'Please specify start point'.
- 2) Input '0, 0' press enter, then prompt 'please specify cross point'.
- 3) Input '300,200' press enter, prompt 'please specify radius'.
- 4) Input 50 press enter. All operations are completed. As shown below.

```
Please specify cross point:
*Cancel*
Command: Delete
Command: New Rectangle
please specify start point:(369.872, 199.8971)
Please specify cross point:(943.3059, -72.0406)
Completed
```

2.5 Automatic Adsorption

The drawing operation will activate the automatic absorption, including absorb to the grid, graphic key point, absorb to graphic boundary etc.

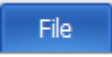
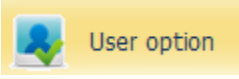
You can close the automatic absorption function in  menu-
, in 'Drawing' page deselect the Auto attach keypoints option. You can also set absorb precision in this dialog box.

2.6 Graphic Drawing

CypCut provides graphic drawing function. On the left toolbar from top to bottom is: Isolated point, straight line, poly line, circle, arc, rectangle, polygon, text, standard parts. The first 5 functions are standard drawing functions similar with CAD.



2.6.1 Standard Graphic Drawing

Drawing isolated point, line, poly line, circle, rectangle are easy to operate will not put details here. There are two options under Draw - circle drop down menu: '**Replace circle as point**' and '**Replace by circle**'. This function can replace circle as isolated point or replace graphic as circle.

In Polygon drop down menu there are rounded rectangle, polygon and star shape. To draw a rounded rectangle you have to draw a rectangle first then specify the fillet radius or directly input fillet radius in bottom window; To draw a polygon or star shape, you have to specify the number of edges (from 3 to 100); The number of edges for star shape is the point angle number. Besides, in Draw menu, under

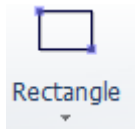

there is Obround shape option, the way to draw Obround similar with rectangle, then add a semicircle to both ends of the rectangle.

2.6.2 Text Input

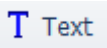
In CypCut users can input Text and transfer text into curves. Click  in left toolbar and point at screen to insert text.

Select text there will be a 'Text' column at the top toolbar, users can modify the text, type and size etc., as shown below:

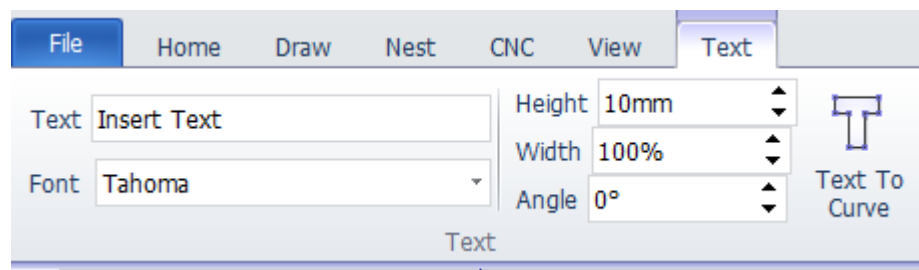

Please take notice that after transfer text to curve above functions will be not available. After you finish all design and settings of the text, transfer the text to curve at last operation.



2.6.3 Standard Parts

There is standard parts library in CypCut. Click  button on left toolbar you can draw commonly used parts. Select the part shape then set the parameters. As shown below:

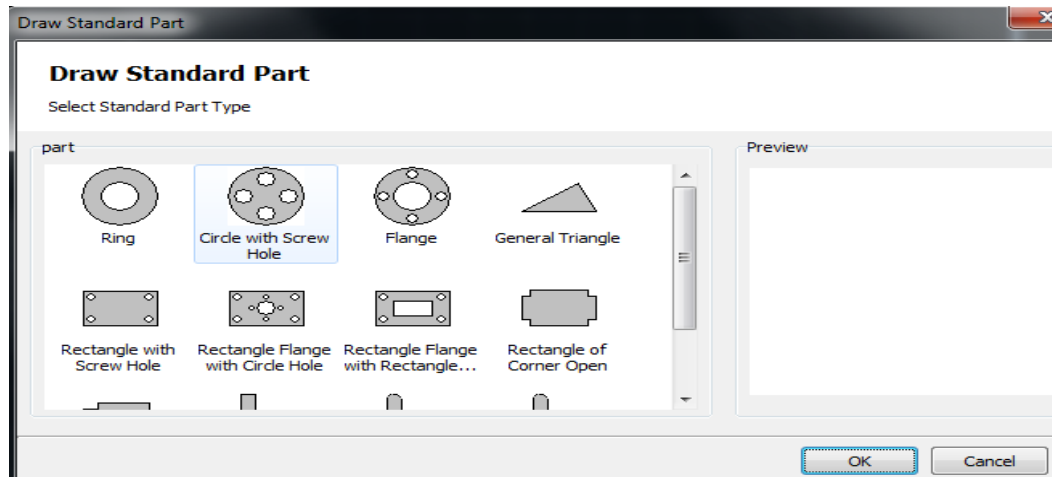

2.7 Measure

CypCut provides a tool for measuring the distance between two points.



Click **Measure** button and select a point on drawing board then click another point, bottom window will show position message between these 2 points.

```
Command: Measure Length
please specify start point:(369.872, -72.0406)
Please specify measure end point:(943.3059, -72.0406)
Length:573.4339, X Direction:573.4339, Y Direction: 0.0000
```

2.8 Graphic Optimization

CypCut will automatically optimize the file. Under Home- Optimize drop down menu users can manually select optimize options.

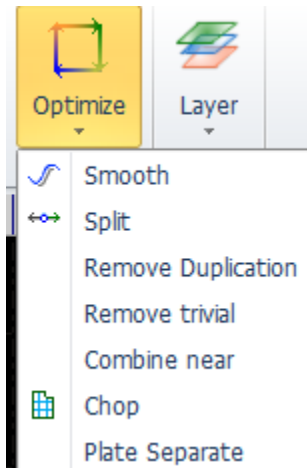

Select graphic, click option and follow the hint finish the operation.

2.8.1 Smooth

Select the poly line need to optimized then click  Smooth button, dialog box will prompt users to input smooth precision, click enter will take effect.

The smooth result shown below. This result get by input a large precision value so it's easy to observe the smooth effect. Users can set the smooth precision as needed.

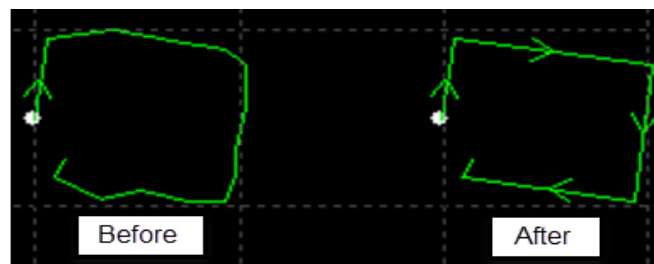

2.8.2 Split

Split function is to break the graphic of closed curve and split as separate graphic for editing. Click  Split at the split position. The split function will be activated until press ESC to disable the function or switch to other command.



2.8.3 Remove Trivial

Sometimes the imported graphics may contain visually imperceptible graphics, resulting in an abnormal position in machining. Users can use this function to remove these minimal graphics by setting the dimension range to define the minimal graphics. Graphics smaller than dimension range will be removed.

2.8.4 Remove Duplication

This function used to remove the overlapped line on the closed contour.

2.8.5 Combine Near

The graphic created by AutoCAD might be visually closed contour but not in fact. Users can use this function to combine unclosed contour. Select the unclosed contour and click **Combine near** , input combine precision.

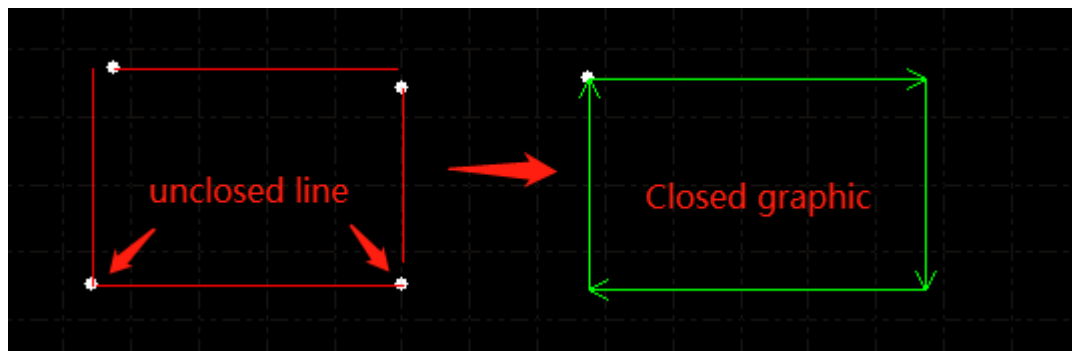

Please take notice that there might be excess line at geometry end, split and remove the excess line then combine the contour.

2.8.6 Chop

This function is to add cut lines at in part holes to prevent tip-up collision. The cut lines in white color to be different with part graphic.

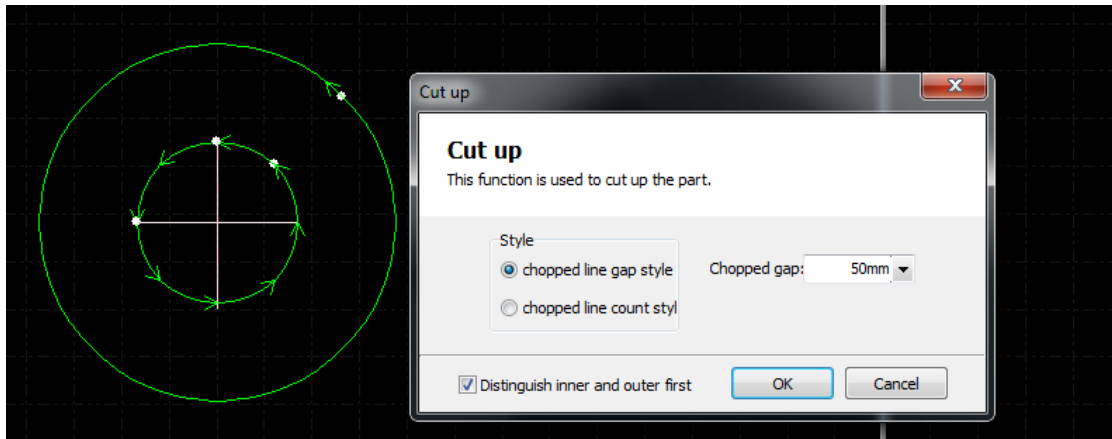

2.8.7 Plate Separate

To divide a graphic drawing in several parts to fit the machine working area.

Partitioned drawings framed by red box need to be saved separately.

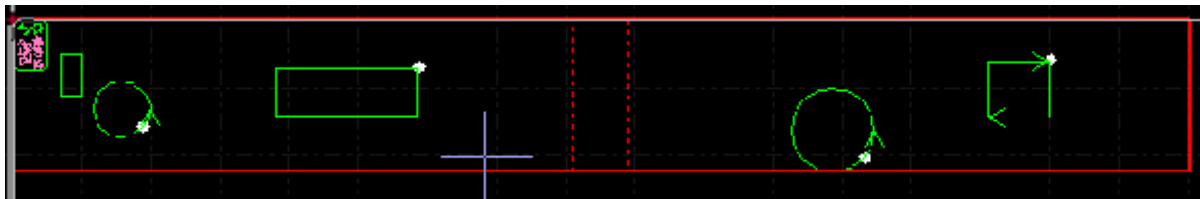

2.9 View

Users can zoom and edit graphic, adjust graphic position and sequence etc.

Function entry is on the top of the left toolbar. From top to bottom is select, node edit, manual sort, pan view and zoom.



2.9.1 Node Edit

CypCut provides node editing function for fine-tuning graphics. Select graphic and click  you can see the nodes of the graphic. Drag a node to adjust the graphic.

Click  again will disable the function.

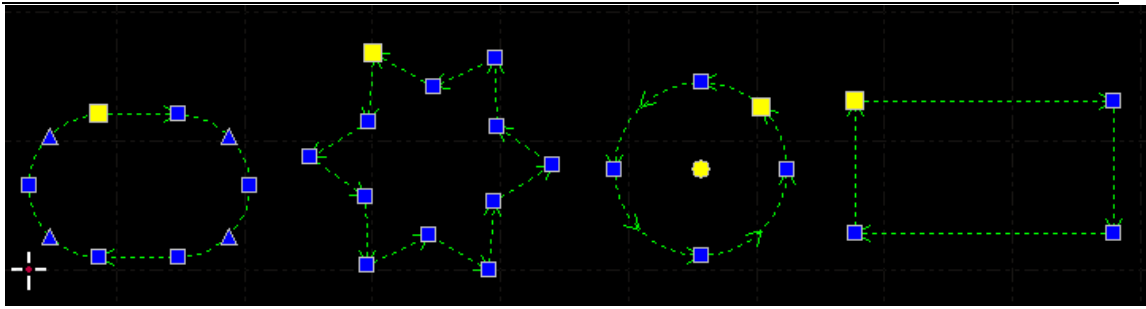

Nodes in blue and yellow both are editable.



3. Graphic Technique and Tools

This chapter describe the functions relate with cutting technique. Users need to set the parameter according the material, laser, gas etc., which are directly involved in the cutting technique. All parameters should be considered as reference not a guide value.

Warning! Improper or incorrect parameters may result in bad cutting performance even damage the machine.

3.1 Lead Line

3.1.1 Distinguish Inner and Outer Contour

CypCut will distinguish the inner and outer contour automatically when import external file like DXF. Inner and outer contour will reverse in editing the graphic. If



you need to distinguish inner and outer contour again click , select in drop down menu 'distinguish inner and outer contour when sorting' or click 'Distinguish inner and outer contour' under 'Lead' drop down menu.

CypCut distinguish the inner and outer contour by the boundary relations. It will define the outmost contour as outer contour, the second is the inner contour, the next is outer contour, and unclosed graphic will not be defined as a contour. If you want to set one contour as outer contour, select the contour and contour within as a group. Then right click use group sort will distinguish the inner and outer contour.

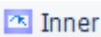
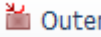
When add lead lines, outer contour cut from outside, lead line add to inner contour will start from inside. Click  Inner  Outer in Home menu you can manually set inner or outer contour.



3.1.2 Automatic Lead Line

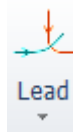

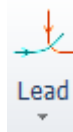
Select the graphic will and click  under Home menu. Set the parameters like below image:

Lead Lines Params

Set Lead Line

This function is used to set lead lines.

Lead in

Type: Line Length: 50mm
Angle: 45° Radius: 1mm
 Add small hole at start point Hole Radius: 0.5mm

Lead Out

Type: Line Length: 1mm
Angle: 45° Radius: 1mm

Lead Position

Automatic Lead Position
 Introduce from vertex
 Introduce from long edge
 Set by Universal (0~1) param 0.00
 Change leads type, remain position

Options

Only for Closed Grap
 Only applies to outer Only applies to inner

OK(O) Cancel

Users can add different type of lead line including straight line, arc, straight line and arc, and other settings including lead angle, length and radius. You can also add little circle at lead line start point.



When select lead line as arc type, the end of arc will be tangent with graphic.
The line connects arc two ends form the angle with graphic boundary. The lead-out line is similar to this.

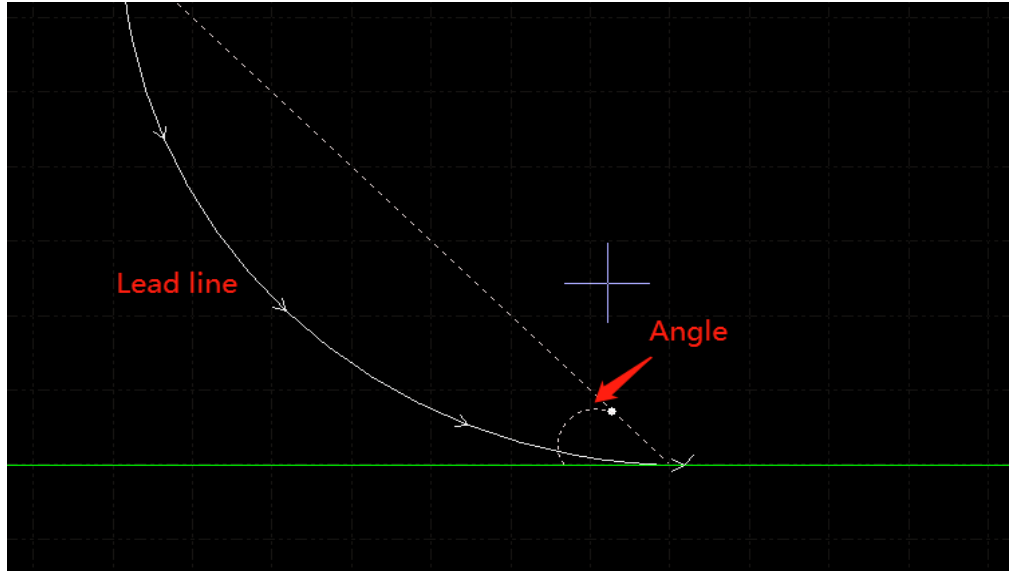

Please take notice that executing auto-add lead line will change the previous setting. You can select Change leads type, remain position to fix the lead line position.

3.1.3 Manual-set Lead Line

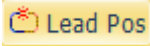
Click  Lead Pos to change the lead-in line manually. Click on graphic only change the lead in line position, lead length and angle remain same.

Click outside the graphic then click back on graphic will create a new lead line.

3.1.4 Check Lead Line

Click 'lead' drop down menu and select 'check lead line'. This function will examine all lead line and adjust lead line length if it's too long and cross with graphic. Click 'distinguish inner and outer mold' it will examine all lead lines and adjust lead line direction according the lead line is add on inner or outer contour.



3.1.5 Overcut, Gap, Seal and Multi-cut

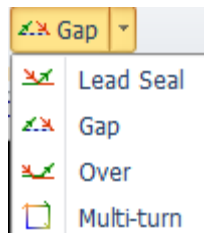

There are 4 options **Lead Seal**, **Gap**, **Over**, and **Multi-turn** in technical parameter column. Select graphic and click function button will take effect. The 'gap/overcut' setting will not take effect to the graphic already set gap or overcut.

3.2 Seam Compensation

Select graphic and click **Compensate** in toolbar to add cutting seam compensation.

Seam compensation should be accessed by measuring real cutting result. The compensation displayed in white on drawing board. Machining will refer compensation line as tool path. Original graphic still display on drawing board but not as actual tool path.

The compensation is inside/outside contour can be set manually or automatically.

Users can also add fillet on compensation line at corner like below photo:

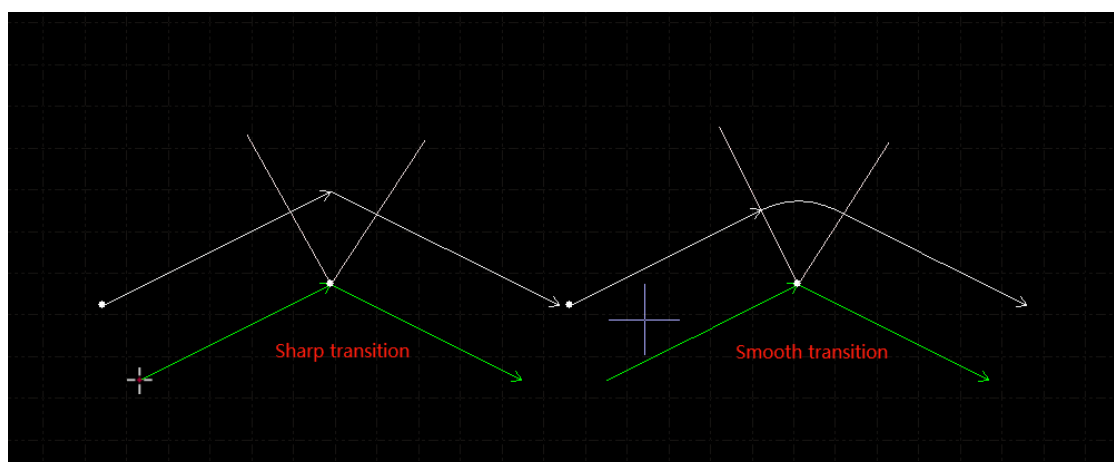



In the photo, the line of green is original graphic, white line is compensated path. It requires smoothing at corner. Usually round corner will smooth the machining path and assure the consistence of graphic and cutting result.

Users can edit compensation parameter and build a library in compensation-configuration-edit.

To remove the compensation you need to select graphic first then click

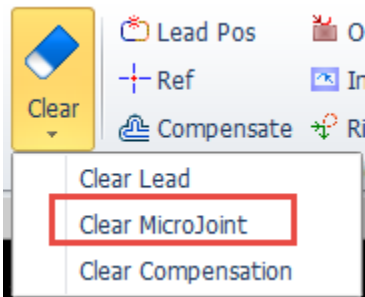



drop down menu select 'clear compensation'.

3.3 Micro-joint

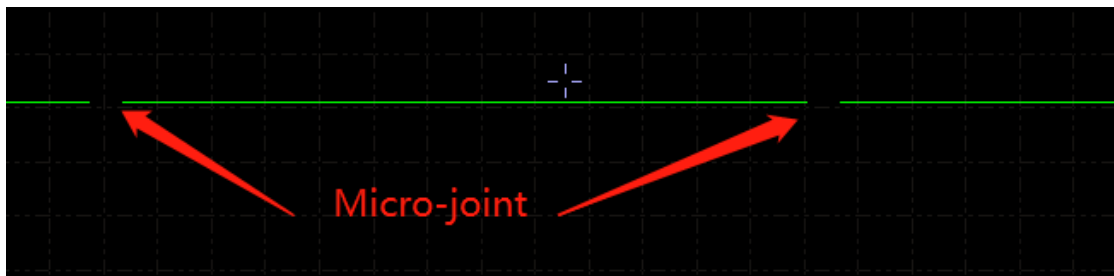

Micro-joint is to add a small distance joint on the graphic. Laser will not fire on the graphic where add micro-joint. By doing this parts will not fall from the plate skeleton also prevent tip-up collision. Micro-joint displayed as a breach on the drawing board:



Click  Micro Joint  in technical parameter column to activate the function then click on the graphic where need to add micro-joint. You can click multiple times to add more than one micro-joint until press ESC or switch to other command. You can also click on the compensated line to add micro-joint.

Micro-joint length setting will not change the previous set micro-joint.



You can also add auto micro-joint. Click  **Micro Joint** drop down menu and select  **Auto MicroJoint** will prompt a dialog box for parameter setting. You can add by micro-joint count, for example, if set 10, each graphic will add 10 micro-joints; or by distance, set 100 it will add a micro-joint every 100mm interval.

Micro-joint will divide the graphic into separate segments. If you want to edit

each segment separately, select  **Micro Joint** in drop down menu. After execute 'explode micro-joint', each segment is an individual object to edit, you can add lead line on each segment.

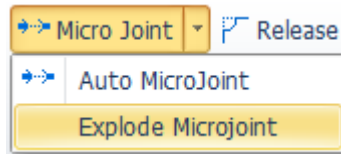

To delete micro-joint, select the graphic then click 'Clear micro-joint' under 'Clear' drop down menu.

CypCut V731 and above adopts FlyCut strategy cutting micro-joint segment, the laser head will not lift up and pass the micro-joint segment without slowing down, which will increase the machining efficiency.

3.4 Cooling Point

Click  **Cooling Point** button then click on the graphic will add a cooling point. When the machining executes cooling point, it will turn off laser and open gas maintain a preset delay, then open laser turn off gas and resume normal machining again. The cooling point is shown as a solid point white dot in the drawing board as follows:

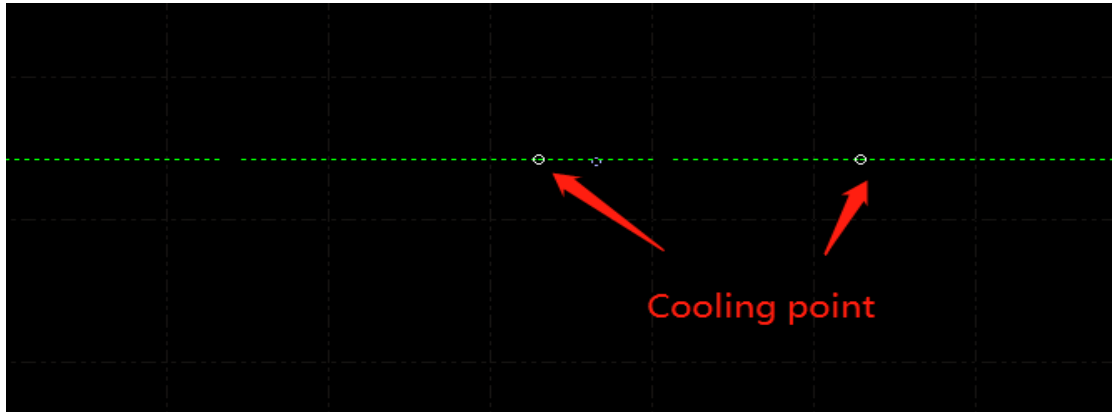

Like micro-joint, the cooling point can be clicked continuously to insert more than one. After you finish setting micro-joint and compensation can still add cooling point.

CypCut can also add cooling point automatically. Click

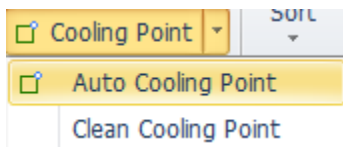

drop down menu and select 'Auto cooling point' and set parameters in dialog box. There are two positions users can select to add cooling point automatically: sharp corner and lead line. The cooling point add on lead line will integrate with lead line. For example, if click 'Clear cooling point' will not delete the cooling point on lead line. Only delete lead line can remove the cooling point add on lead line.

Press shift and click cooling point you can delete it. If you want to delete cooling point, click drop down menu of cooling point and select 'clean cooling point'.

Cooling point is often used in processing workpiece corner, it will pause at cooling point, turn off laser and gassing to lower the corner temperature avoid corner burned.

3.5 Ring Cut

Select graphic and click  to create an extra path to improve sharp corner cutting performance.

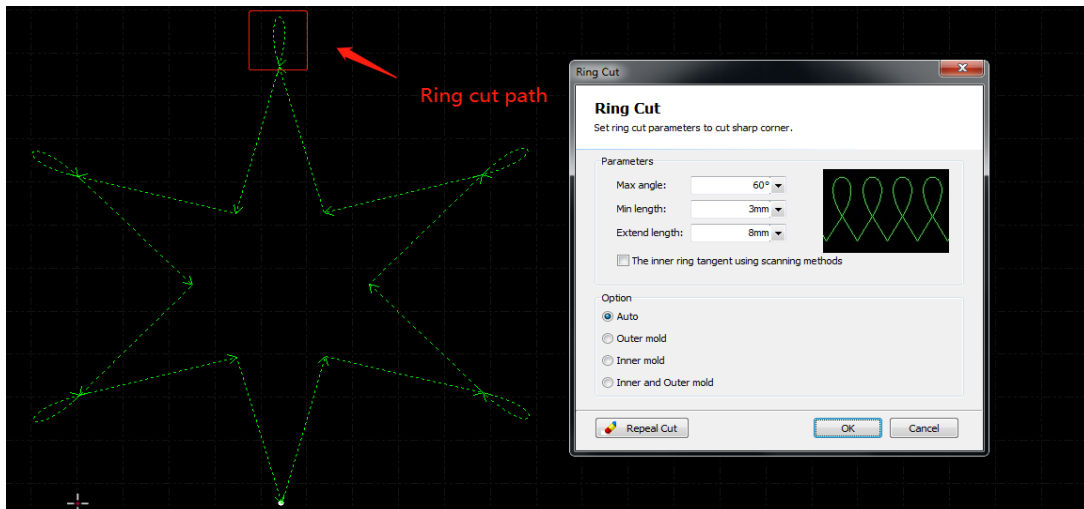

3.6 Fillet/Release

Click  to transfer sharp corner into rounded corner.

Click  to create a release notch for bending process.

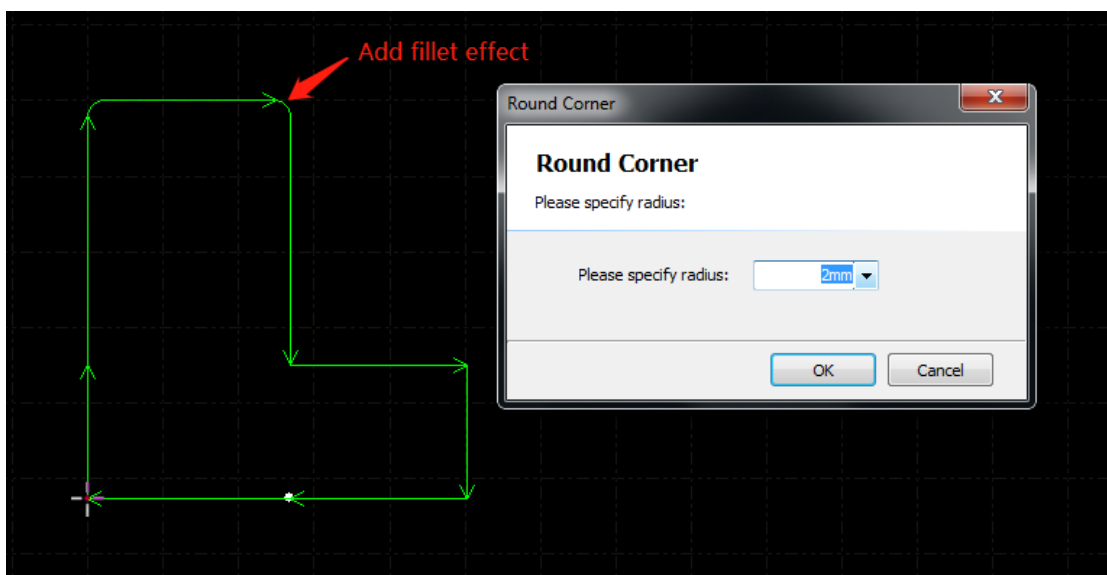

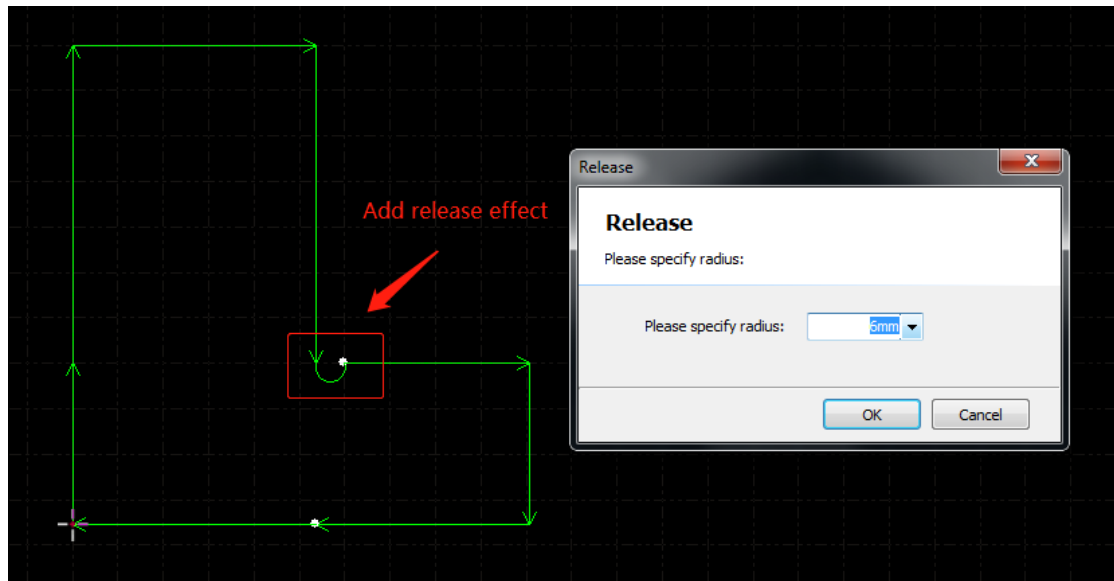

3.7 Group

Group function in CypCut is to integrate multiple graphics as a group. A group will be recognized as an independent object. The sequence and position of the graphics within a group are all fixed and will not change by other operations.

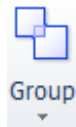

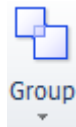
Select the graphics and click  will create a group. If you need to disperse a

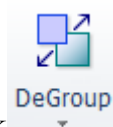

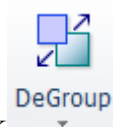
group, select the group and click . If you need to disperse all groups click

drop down menu of group and select Degroup all.

'Degroup' will not disperse the graphics only the group. 'Explode graphics' will disperse the graphics as line segments.

'Multi contour cut together' will create a path connect the group which will reduce the piercing times and improve the efficiency. 'Explode multi contour cut' will clear the connecting path.



For a group, if there is one graphic contains all other graphics, this graphic will be defined as outline. The group with outline will be defined as a 'part'.

It's recommended that CypCut users create 'Group' to integrate a part not just group graphics randomly. We might use term 'part' same concept as 'group'.

CypCut will integrate co-edge graphics as a group. In addition, use 'Bridge' function to connect a group with other group the result will be a group.

3.7.1 Sorting of Group

The group will be defined as an independent object in sorting. The sequence of the graphics within a group won't change in sorting.

If you need to edit sequence of graphics within a group, select a group and right click, select 'group sort'.

'Group sor' operation will not change the sequence of graphics in sub-group. It will distinguish inner and outer contour of graphics within a group by geometrical relations.

3.7.2 Machining of Group

Group will be defined as an independent object, until a group is fully processed it will not move on to the next graphic. Piercing of group follow the same rule.

Please take notice that the outmost contour of a part/group will always be processed at last.

3.8 Flying Cut

When the graphics are standard shapes like rectangle, circle or polygon and layout in principles, you can use flying cut function to improve the machining efficiency.

Before use flying cut, execute sorting first, this will optimize the cutting path.

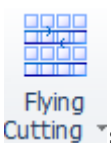

Click drop down menu of  select flying cut patterns and set parameters.



Start position defines where to start flying cut. Max joint distance: it will create a smooth cutting path to turn around if the turning distance is shorter than this value. Max scan length: if the distance between two graphics longer than this value it's not able to create fly cut path.

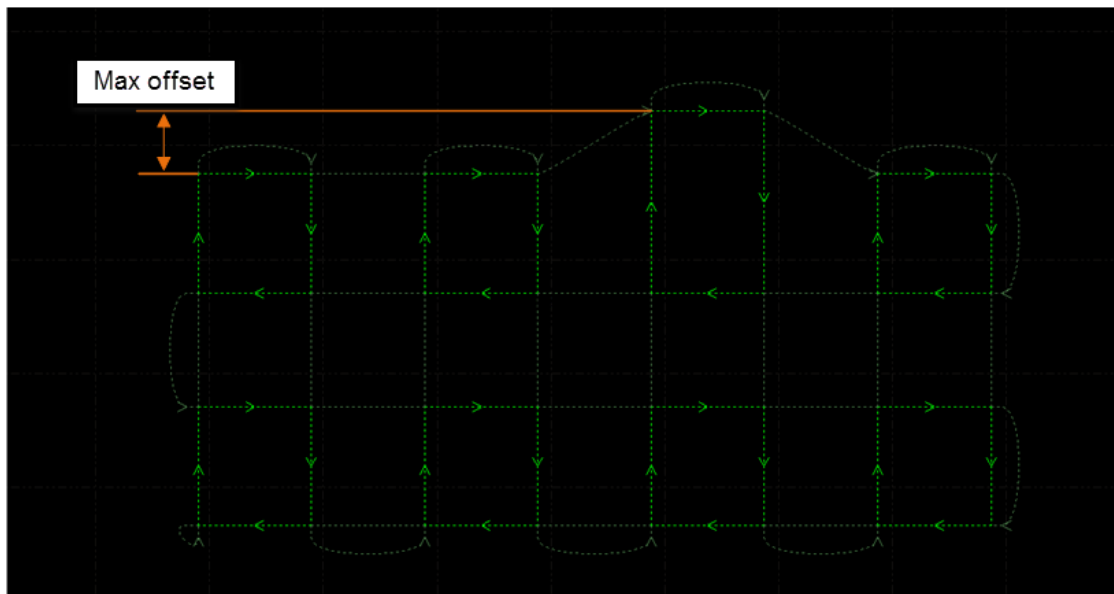
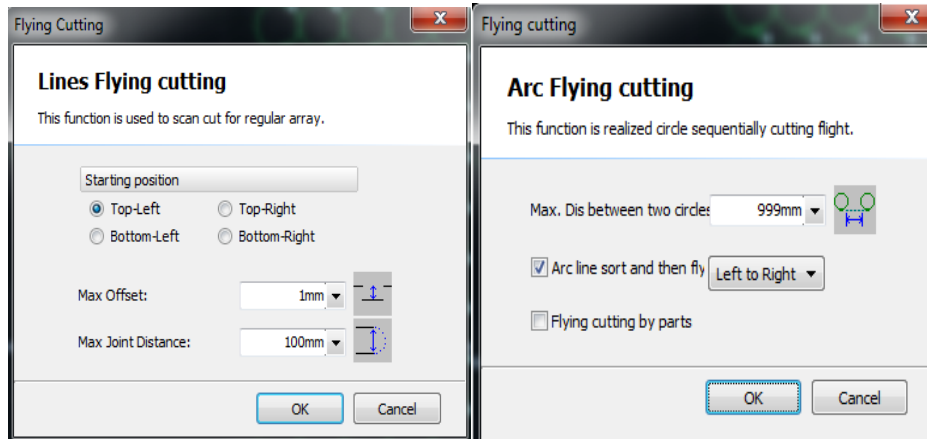

When the graphics in a layout are all circles, select 'Circles flying cut' pattern.

Max distance between two circles: only the distance between two circles shorter than this value can create fly cut path.

Select Arc line sort and then fly will execute sorting first then create fly cut path, if select with Flying cutting by parts it will process the graphics within a group then process next group.

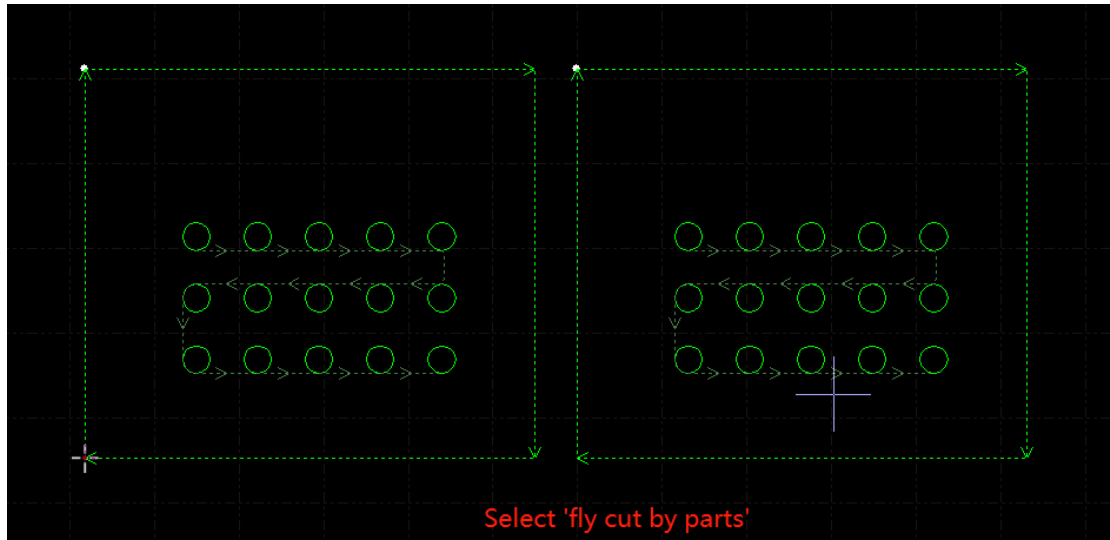

Select Flying cutting by parts only, it will execute sorting then create fly cut path.

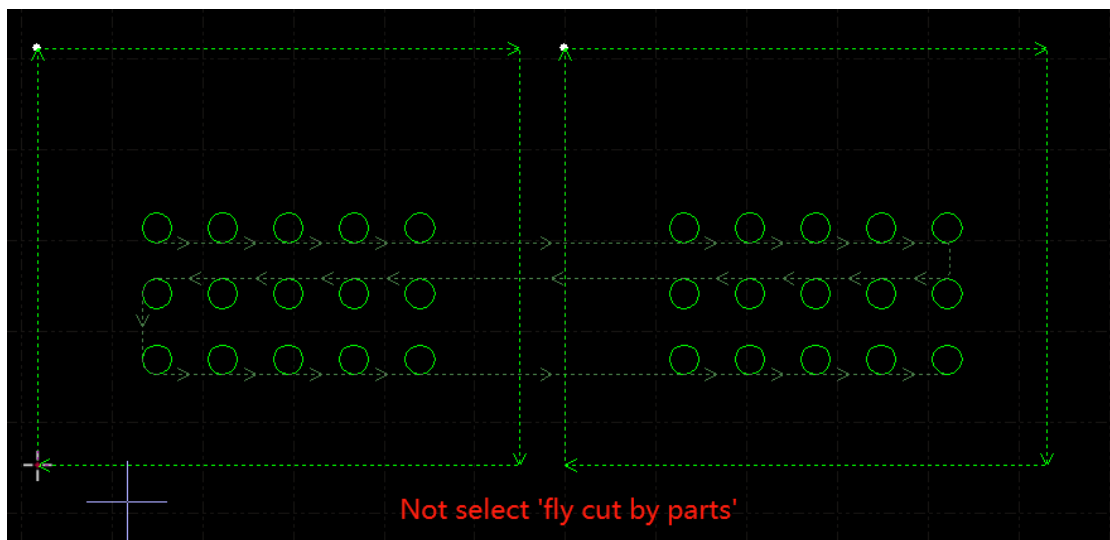

In global parameter page, set a fly cut over-cut distance will assure parts will fall down from skeleton plate.



3.9 Co-edge

Merge the shared line of two parts as one will reduce the cutting length. In CypCut, the parts of space smaller than 0.1mm can use co-edge function. CypCut provides graphic absorb function to snap two graphics and merge the shared lines.



Select the graphics and click , it will merge the shared lines of the selected graphics.

CypCut cannot merge the inward concave lines of the graphics.

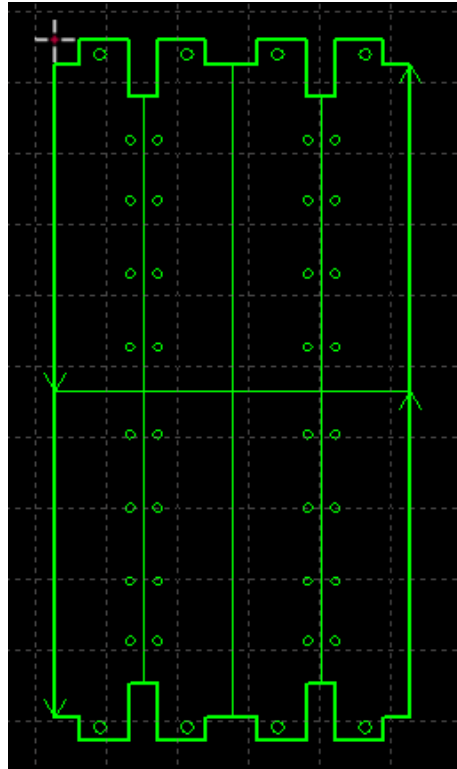

The graphics merged shared lines will be integrated as a group. If the graphics which are going to merge the shared lines contains other graphics inside like circles, you have to group the graphics first.

3.9.1 Automatic Absorb

When drag the graphic, it will attach to another graphic automatically when in the position fit for co-edge. Absorb function will help you quick adjust the position of graphics fit for co-edge.

Once graphics attach with each other with shared lines, click

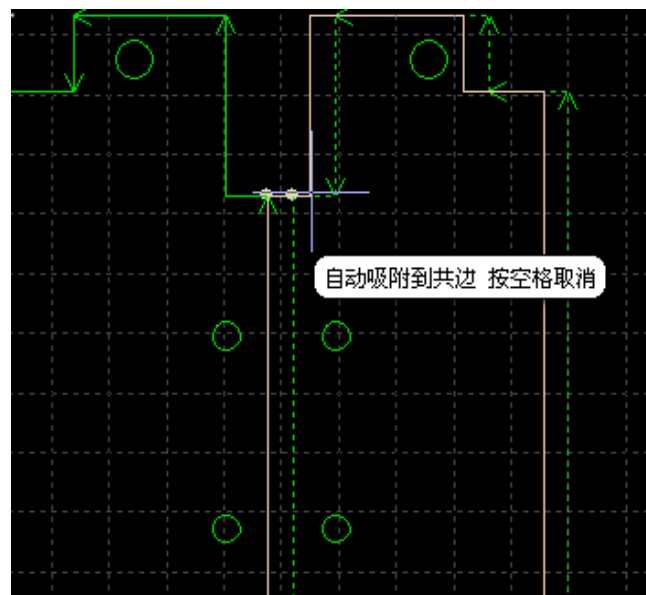

**Coedge**

will create the co-edge. If you want to disperse the graphics with co-edge, click 'explode graphics' under 'group' drop down menu.

3.9.2 Co-edge with Compensation

If you want to add cutting seam compensation to the graphics, you have to add compensation first then execute co-edge. The graphics of co-edge add compensation, then only compensation line remained.

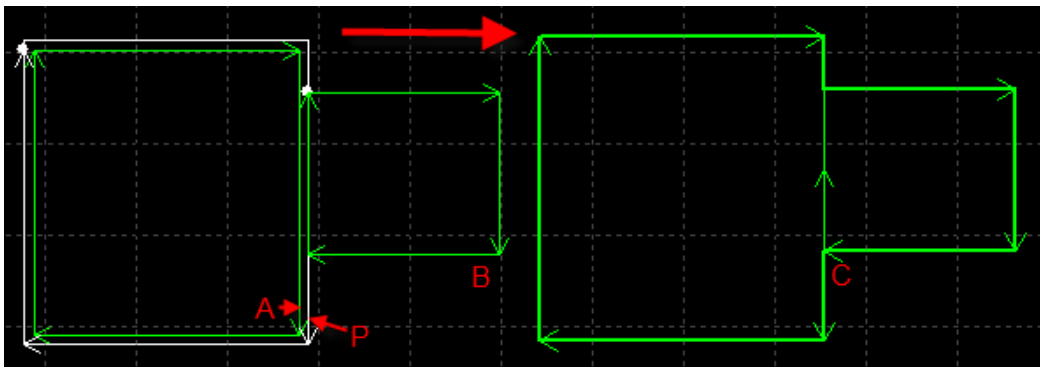

For example, in the above picture, graphic P is the compensation line of the graphic A, only graphic P can co-edge with graphic B because graphic A is not real cutting path.

3.10 Bridge

When a workpiece contains several parts and you want to keep them connected, you can add bridge between graphics. And graphics with bridge also reduce the pierce times.

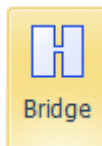

Click  and drag a line segment on the drawing board, the graphics cross with the line segment will be bridged like below image.

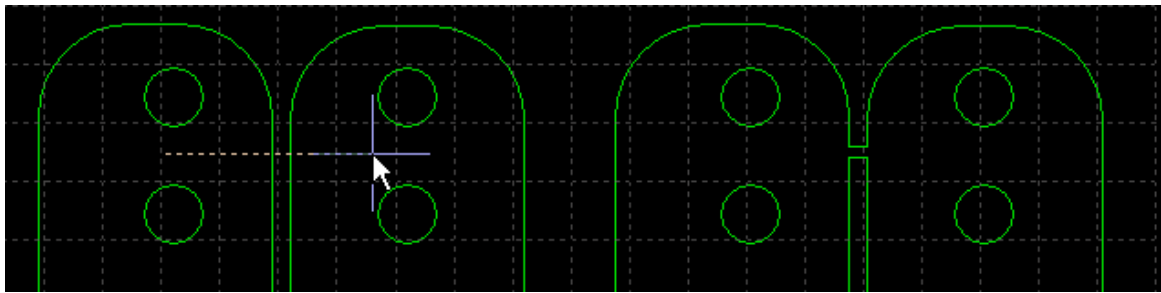

There are two parameters to define the bridge function. One is the max distance between two adjacent graphics, only the distance between two graphics smaller than this value can add bridge. The other is the width of the bridge.

The graphics add bridge will be recognized as group, please be careful that the continuous cutting will cause heat affect to cutting quality.

3.11 Array

The 'Array' function used quick duplicate a graphic, there are 4 patterns of Array in CypCut.

3.11.1 Rectangular Array

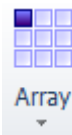

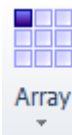
Click  under Array drop down menu will prompt the below page:

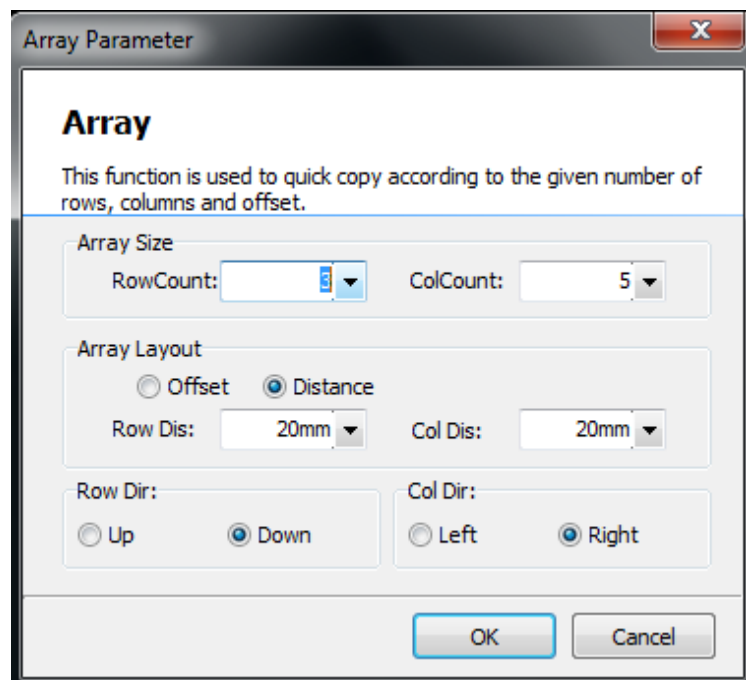



Set the lines and columns of the array will duplicate the selected graphic.

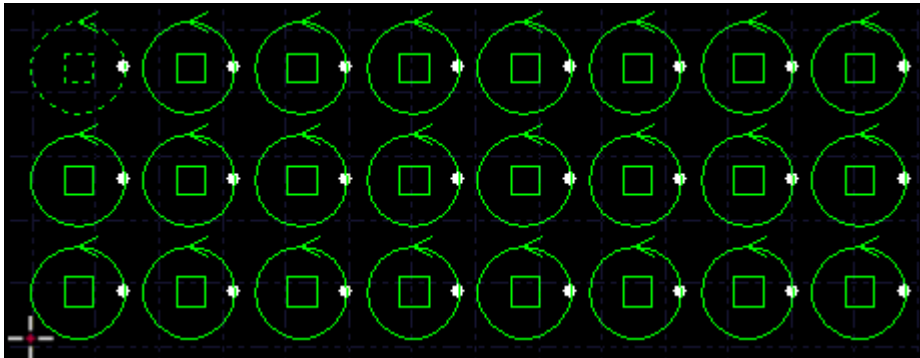

3.11.2 Manual Array

Select 'Manual Array', set the line space and column space, drag the cursor will duplicate the selected graphic.

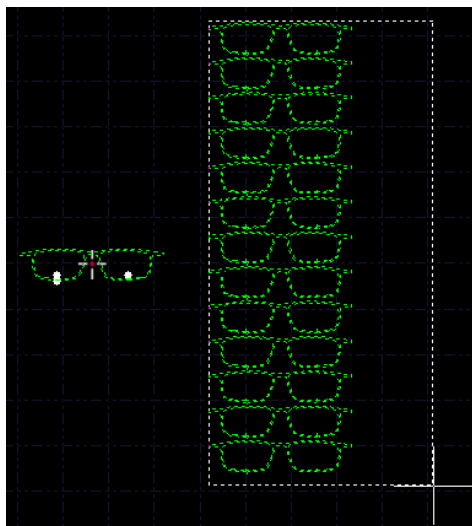

3.11.3 Circular Array

This pattern will duplicate the graphics in a center and create a circular layout.

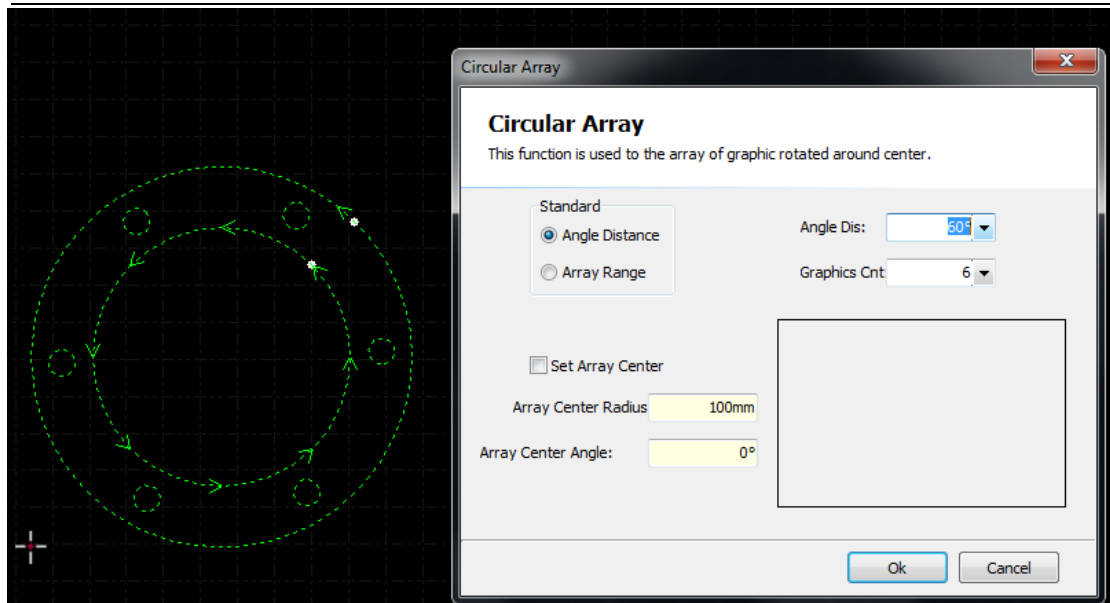

3.11.4 Full Fill

This pattern is used to duplicate the graphic and cover the whole plate by pre-set plate dimension.

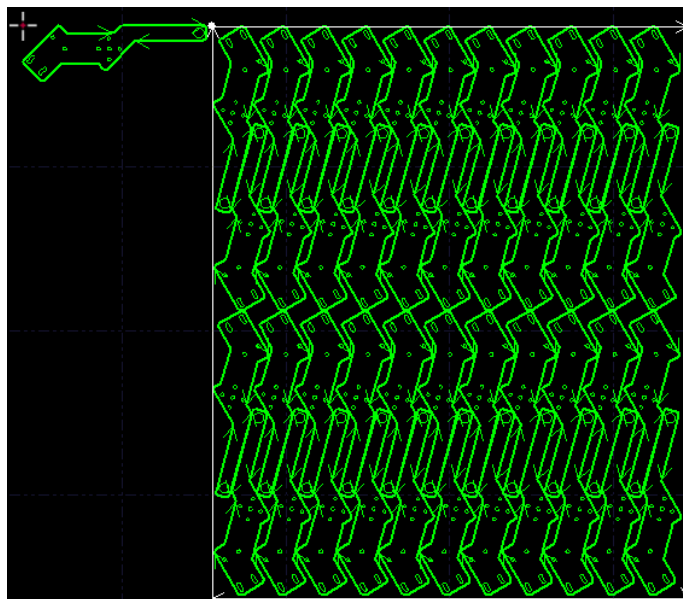

3.12 Quantity Modify

To edit a graphic and apply the result to all graphics same with this graphic, you can use quantity modify.



Select the graphic and click **Quantity modify** in Home menu will open the quantity modify window, if you set lead line to the graphic, it will apply to the graphics same with the current graphic.

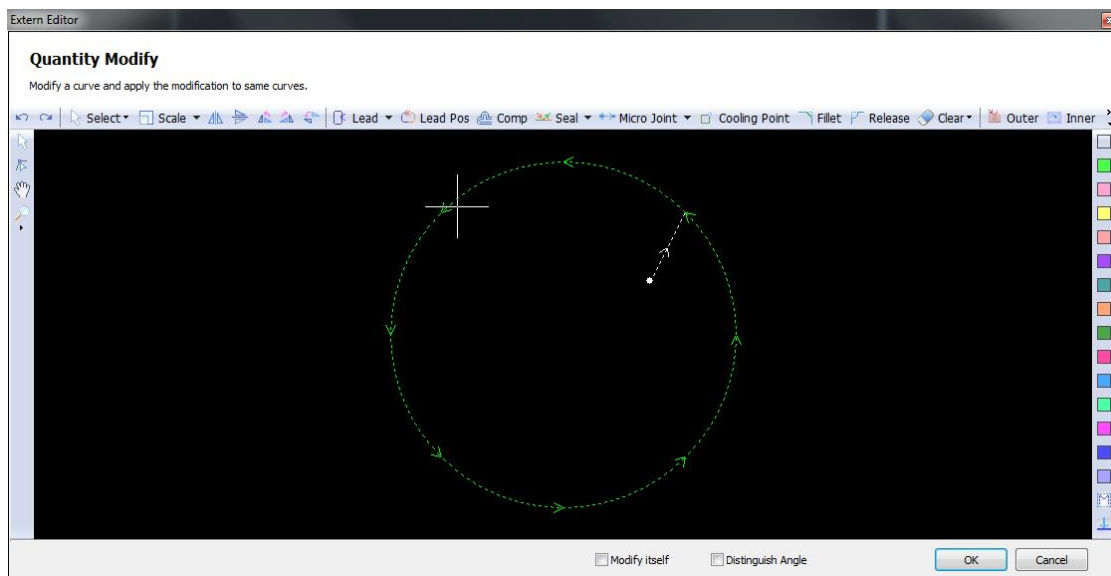
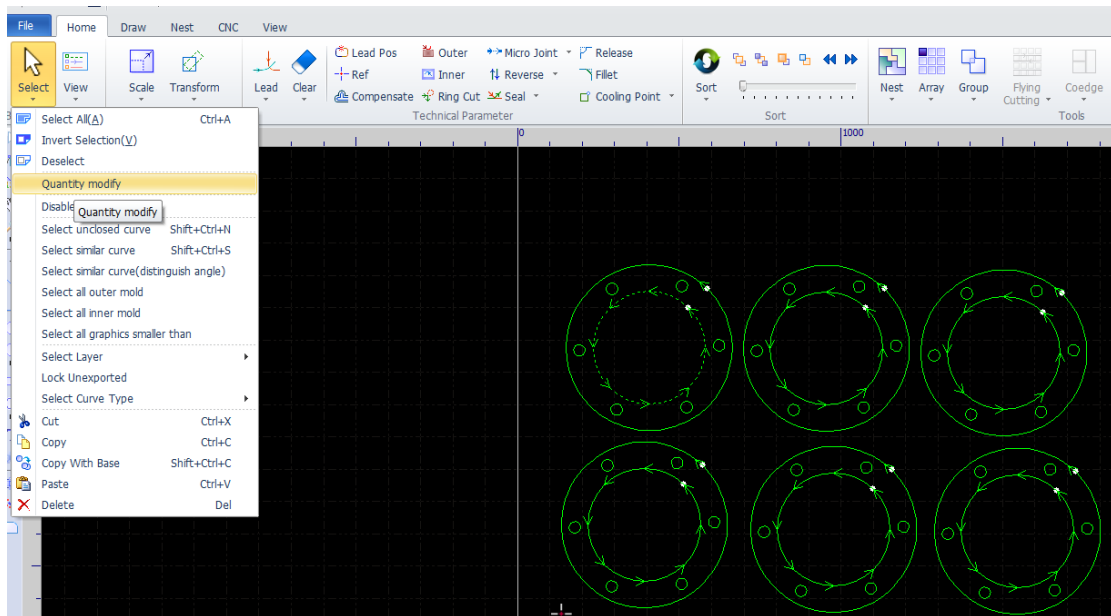

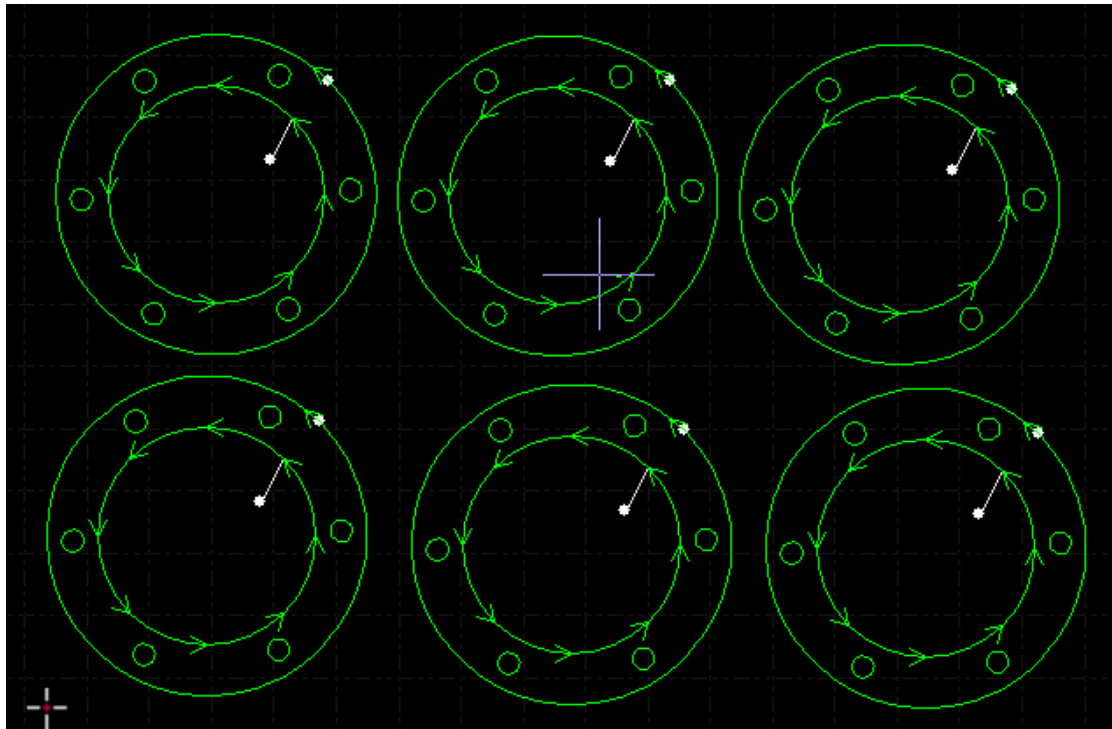

3.13 Cutting technique

There are 16 layers in CypCut, users can set the cutting parameters to each layer including cutting speed, laser power, gas pressure and nozzle height etc. The last two layers are 'process at the first' and 'process at last'.

Click 'Layer  ' in Home menu will open layer parameter window contains almost all parameters related with machining. The first page is 'Global parameter' used to set default parameters used universally in machining. The other pages list all the layers applied, click the layer page to set the parameter of this layer.



Layer Parameter Settings

Global Parameter **layer1** Evaporation Layer

Material: carbon steel Thickness: 2.0mm nozzle model:

Short Move Pre-pierce Evaporation film Path Cool Multi-times 0 Keep puffing Disable Disable Follow Standard

Cut Pierce Lead

Cut Speed: 16.662 mm/s

Lift Height: 9.91 mm

Cut Height: 5.994 mm

Cut Gas: Nitrogen

Cut Pressure: 6 BAR

Cut Cur: 0 %

Cut Pwr: 0.1 %

Cut Freq: 1 Hz

Beam Size: 0 x

Cut Focus: 5.994 mm

Delay Time: 0.0011 min

Laser off delay: 0.0011 min

Slow Lead Length: 0 mm Speed: 2.007 mm/s

Slow Stop Length: 0 mm Speed: 2.007 mm/s

Dymc Pwr Adj Dymc Freq Adj Show in Abs Curve edit

User Notes

OK(O)

Notice: The parameter options may differ for different laser source and gas configuration, the parameter in the image can only be reference, users must set the parameters by actual software display in your own machine.

3.13.1 Parametric Description

The following table gives a brief description of some of the parameters in the layer.

① Basic parameters	
Cutting speed	Set the target speed of actual cutting. Because of the acceleration and deceleration in machining workpiece corner, the actual cutting speed is usually slower than the set value.



Lift height	After process a graphic segment laser head will lift to this height and move to next start point. When pause the machining, laser head will lift to this height.
② Machining mode	
Standard	Machining will follow the preset parameters.
Fixed height cutting	Laser head will be at a fixed height in whole cutting process.
Extra plate follow	Select this mode, the laser head will start outside the plate and follow to cut height once move within the plate. Locate laser head at a suitable position, in CypCut-CNC-BCS100-Save extra-plate follow reference height set the parameter.
③ Machining parameters	
Cut height	Set the following distance between nozzle and plate.
Gas type	Set the type of auxiliary gas used in cutting.
Gas pressure	Set the pressure of axillary gas in machining, this requires proportional valve.
Peak power	Set the peak power of the fiber laser. Peak power determines the maximum cutting power that the machine can achieve. If the peak current is set to 80%, the maximum cutting power is $3000W * 80\% = 2400W$.
Cut pwr	The duty cycle of PWM modulation signal.
Cut Freq	The frequency of the PWM modulation signal which is the times of laser fires within 1 second.
Cut Focus	The position between focus with nozzle tip.
Delay Time	The duration of laser firing to confirm laser cut through the workpiece at the start.
Laser-off delay	A delay before turn off laser.
Step time	Set the time required that laser head descends from pierce height to cut height.



Extra puffing	After finish pierce actions, it will turn off laser and open gas to cool down the material temperature.
④ Other parameters	
Disable	This layer is not going to be processed.
Disable follow	When machining this layer it will close follow function, laser head will be at a fixed height.
Keep puffing	Gas is open in the whole machining process.
Short move	This function related with the 'Move optimization in short move' parameter. If the distance from one graphic end point to next graphic start point shorter than this value, Z axis will not lift up on this path.
Pre-pierce	It will pierce at all graphics start point or lead line then start cutting. In 'Global parameter' window there is 'group pre-piercing', enable this function it will execute pierce of one group and complete machining of this group then move to next one. Notice: pre-pierce cannot be selected with evaporative film.
Evaporate film	It will execute filming parameters along the graphics then start cutting. After you select this option there will show a evaporation layer page.
Path cool	After finish machining of one graphic it will turn off laser and blowing gas along the graphic to cool down the material reduce the heat effect to the workpiece precision. After you select this option it will show a Cool layer page.
⑤ Slow lead	
Length	This used in cutting thick material, it will start cutting in a slow speed to make sure plate cut through.
Speed	The speed in this start length.
⑥ Power curve	



Real-time power/frequency regulate	After you enable this function you can edit the power/frequency curve, and program will regulate the laser power and frequency according the curve. This function is very practicable improving corner precision. Notice: 'Dymc freq adjust' cannot select alone.
---	---

3.13.2 Real-time Power/Frequency Regulate

If select Dymc Pwr Adj Dymc Freq Adj the laser duty cycle and frequency will regulate with speed in real time. You can click the button to edit the power/frequency curve.

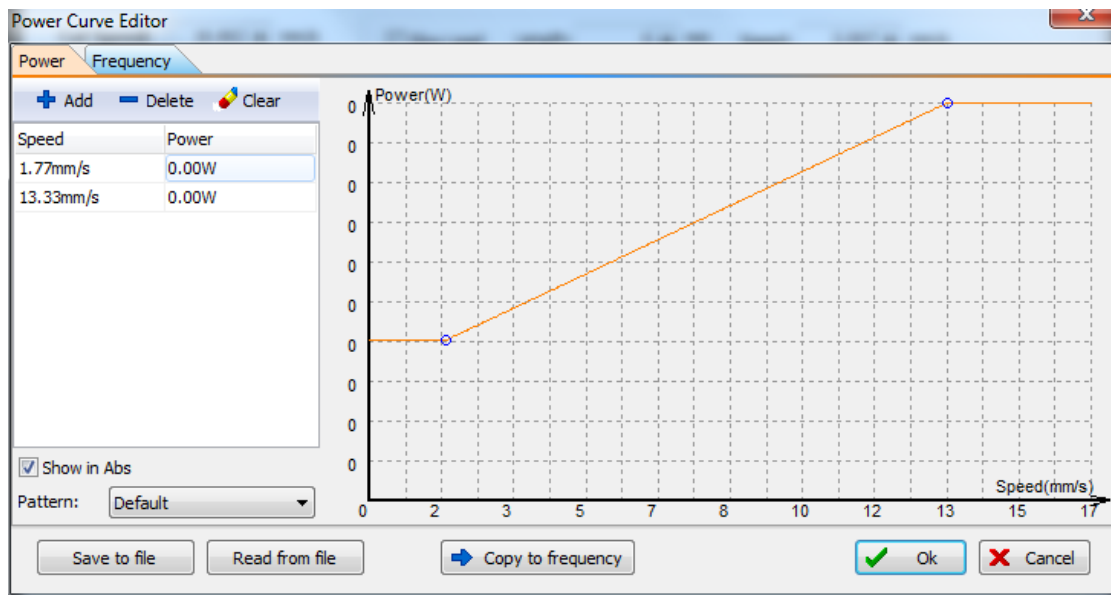

As shown in the photo above, horizontal axis us speed, vertical axis is power/frequency, unit is percentage. You can select the curve pattern and set the power level when machine reaches a specified speed. You can click

copy the power curve to frequency curve. Notice: Only when enable 'Dymc pwr adjust' curve select 'dymc freq adjust' will take effect.

For example, laser power 500W, peak power 90%, cut power 80%, when the actual speed slow down to 29mm/s, the laser power is:

$$500W \times 90\% \times 80\% \times 79.00\% = 284.4W$$



The power will not be lower than 10% of the laser power, for example 500W laser will not lower than $500 \times 10\% = 50W$.

If not select Dymc Pwr Adj Dymc Freq Adj , the cut power will remain not change in cutting process. In the above example, if not select these two options, the power in the cutting process is $500 \text{ W} \times 90\% \times 80\% = 360W$.

3.13.3 Layer Mapping

Click 'Layer' drop down menu users can lock or display a specified layer by select options. When there are more than one layers when import DXF file, click 'layer mapping' it will distinguish layers. Shown as below:

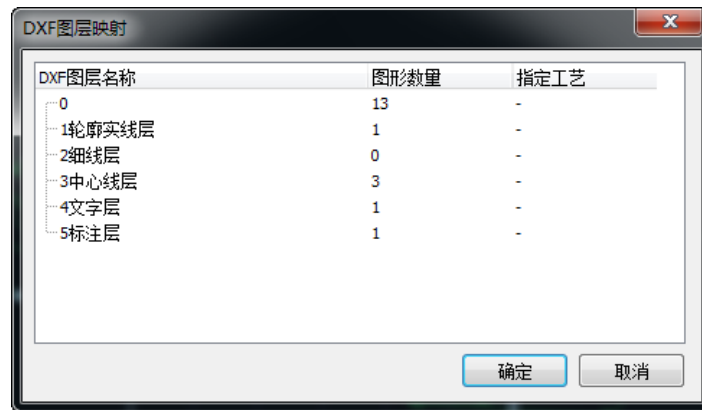

3.13.4 Lead Line Technique

When cutting thick plate of stainless steel will generate plasma cloud which will absorb laser energy and reduce cutting energy, gas can hardly blow off the plasma cloud at cut height. Lead line technique is applied to solve this issue. After execute pierce, laser head will stay at a higher position and blow off the plasma cloud, then slow the speed in horizontal direction to make up the pressure loss.

When cutting thick plate you can set lead line technique including speed, power, lead height and stable distance.

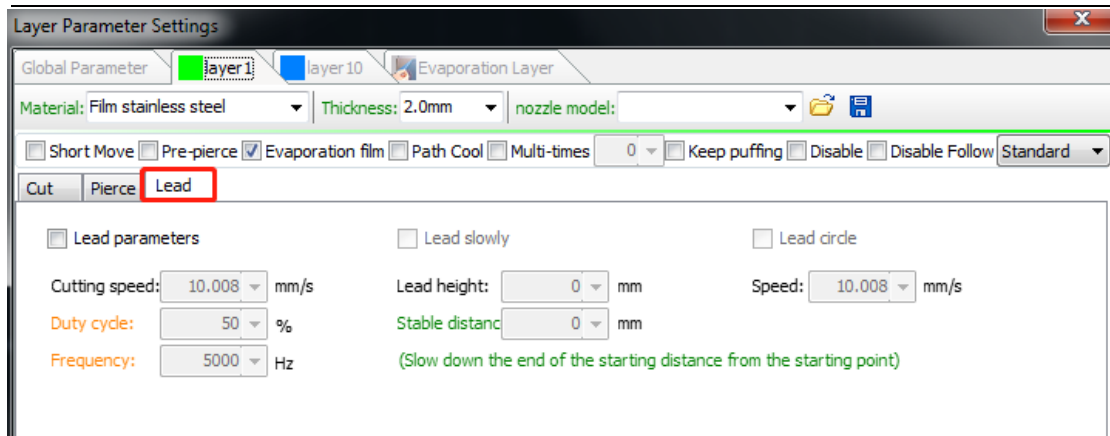

The actions process lead line:

1. Pierce at start point of lead line;
2. Laser head lifts to the lead height to blow off plasma cloud;
3. Laser head descent to the cut height and cut at 'lead speed' in the length of 'stable distance';
4. After cutting out of the stable distance it will start normal cutting.

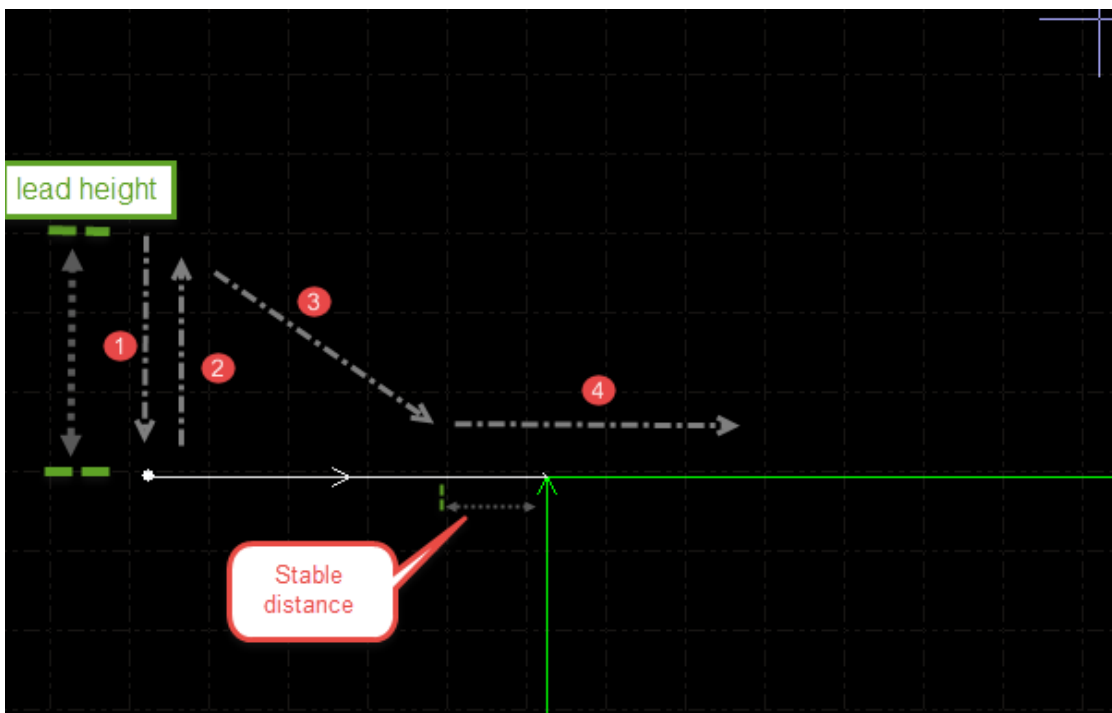



3.14 Nest

Nest function is used to layout the parts in a plate with highest utilization. Users can click nest button to finish nesting. CypCut also provides options to customize the nesting like: Parts gap, plate margin, rotation angle, co-edge and remnant



management etc. You can find nest function button in Home menu and Nest menu.

3.14.1 Nesting

In nesting operation there will be a side bar at left screen to display the parts, plate and nested plate.

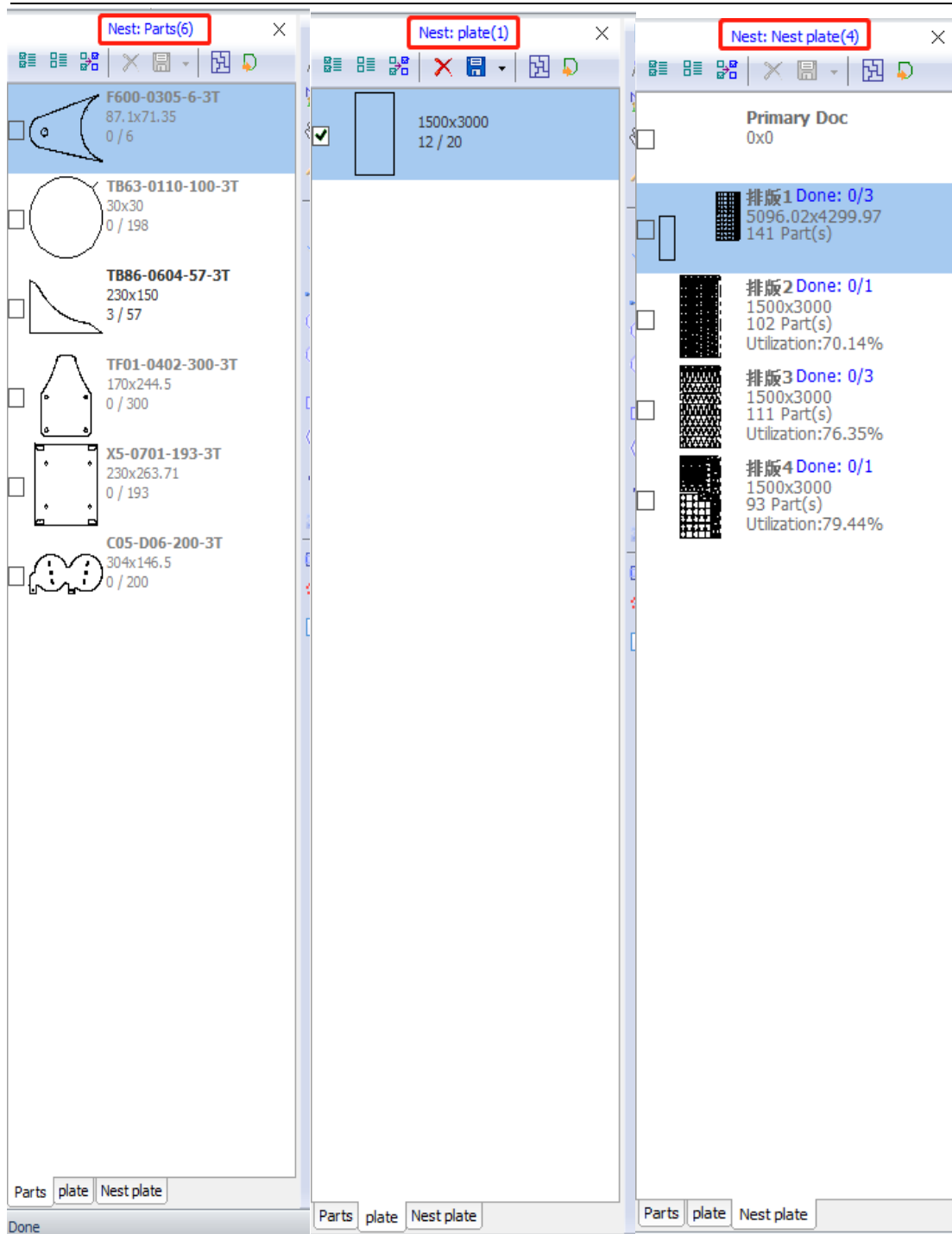

Parts library will list all parts, you can add new parts by right click at parts lib and select 'load parts', or you can select parts at drawing board right click the part select 'add to parts lib'. The parts type limits is 50. Right click at side bar you can choose to import standard part, delete part or save un-nested parts.



Plate library lists the plate and plate quantity, you can add new plate same operation with adding parts. Right click side bar you can choose to delete plate or save as file.

Nest plate lists all nested plates and already processed plates. CypCut now only supports 20 plates nesting at one time.

Users need to set basic parameters for nesting. 'Part gap' is the minimum space between parts; 'Plate margin' is the plate margin left when nesting; 'Nest strategy' only supports array in CypCut.

Auto Nest

Nest

Please enter the board size and then click OK, the graphics will be automatically nest.

Select Parts

- All Parts in Library
- Selected Parts

Only Select plate

- All plates in Library
- Only Selected plates
- Standard plates

2400.00 mm x 1200.00 mm

Length: 2400mm

Width: 1200mm

Plate Material: 冷轧板

Plate Thickness: 1mm

Parameter settings

Parts Gap: 2.00mm

plate Margin: 2.00mm

Nest Strategy: Array

Auto Opt Times: 1

Remnant: Cutting Line

Detail Settings

Clear the nested results at first

OK Cancel

In 'detail settings' you can set parts rotation angle allowed, layout direction, co-edge and remnant material management.

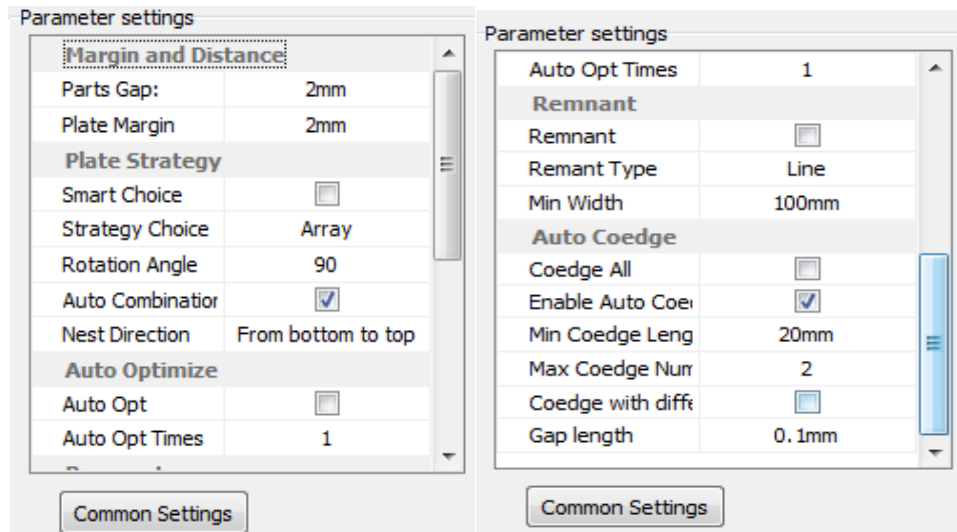

3.14.2 Nesting Report





In 'Nest plate' list right click the plate select 'generate report' and finish the setting about pricing then click 'generate report', it will prompt layer window, the layer parameters used to estimate the cost. As shown below:



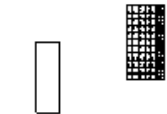

Nest Total Info

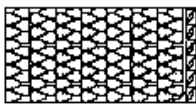
2019/07/04 11:12:29

Plate Info

Order	Thumbnail	Size(mm ² mm)	Parts Count	Cut Total Length	Move Total Length	Plan Process Time	Count
1		5096.02 x 4299.97	141	117435.80mm	112763.86mm	1hours25min5.5s	1
2		1500.00 x 3000.00	102	118390.51mm	87751.95mm	1hours26min41.2s	1
3		1500.00 x 3000.00	111	93583.88mm	82637.95mm	1hours3min25.6s	1
4		1500.00 x 3000.00	93	110592.14mm	98070.19mm	1hours21min30.7s	1

Part Info

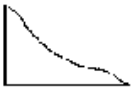
Order	Part Name	Thumbnail	Size(mm ² mm)	Parts Count	Nest Count	Remain Count	Processed
1	F600-0305-6-3T		87.10 x 71.35	6	6	0	0
2	TB63-0110-100-3T		30.00 x 30.00	198	198	0	0
3	TB86-0604-57-3T		230.00 x 150.00	57	54	3	0



3.14.3 File Switch

Open nrp or nrp2(file package generated by CypNest nesting software), it will list all nested plates, also processed times and planned process times. The processed times will add up after the current plate task finished machining. When the processed times reach the planned times it will switch to the next file.

Software version required: CypCut V712.6 and above

3.15 Sorting and Path Planning

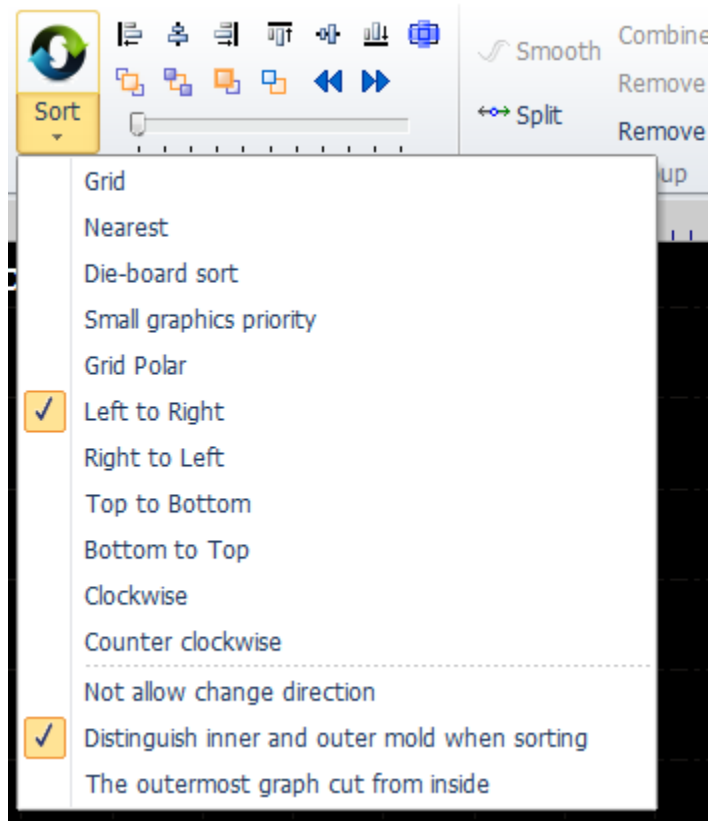

The below function column is in the 'Draw' menu which list all sort patterns and align tools.





If no requirement to the sorting result, just select 'grid sort'.



3.15.1 Sequence Preview

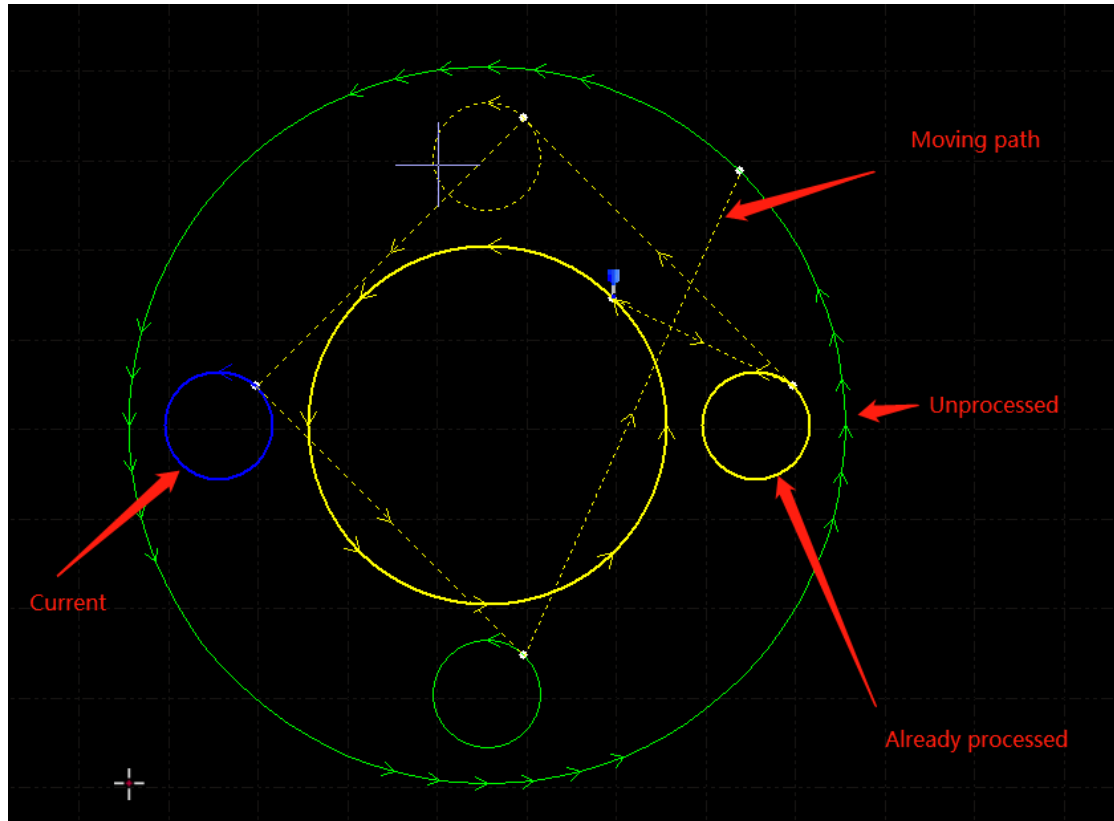



Drag the progress bar or click   you can preview the machining sequence of the graphic. Below picture shows graphic status when preview sequence:

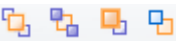

Sequence preview is completely interactive, easier to control the progress forward or backward. You can view the move path to check the overall sequence. Open 'View' drop down menu select  **Show Move Path** .

3.15.2 Manual Sorting

If you want to adjust sorting result, you can manually edit the graphic sequence. Select graphics then click  , the buttons from left to right is:

First		The selected graphic will be the first to process.
Last		The selected graphic will be the last to process.
Prior		Adjust the sequence of the selected graphic one step forward.
Next		Adjust the sequence of the selected graphic one step backward.

After finish sorting, you can click   to check the sequence one by one.



You can open 'Manual sort mode' to edit the sequence. Click  on left bar of main screen will enter 'manual sort' mode. It will display the graphic sequence and path. Click graphic one by one as you required sequence. If one graphic click accidentally, click this graphic again or right click to cancel the operation. If you just want to edit the sequence between two graphics, just click a graphic drag a red line to the other graphic will set the new sequence of these two graphics.

3.15.3 Group Sorting

If you want to fix the sequence of certain graphics, you can group these graphics. The sequence of the graphic within a group will not change in other sort operation. When process the graphics within a group, it will not process other graphics doesn't belong this group till the group is finished.

If you only want to sort a certain graphics, group these graphics and use 'group sort' function. Select graphics and click 'group'-right click group - select 'group sort'.

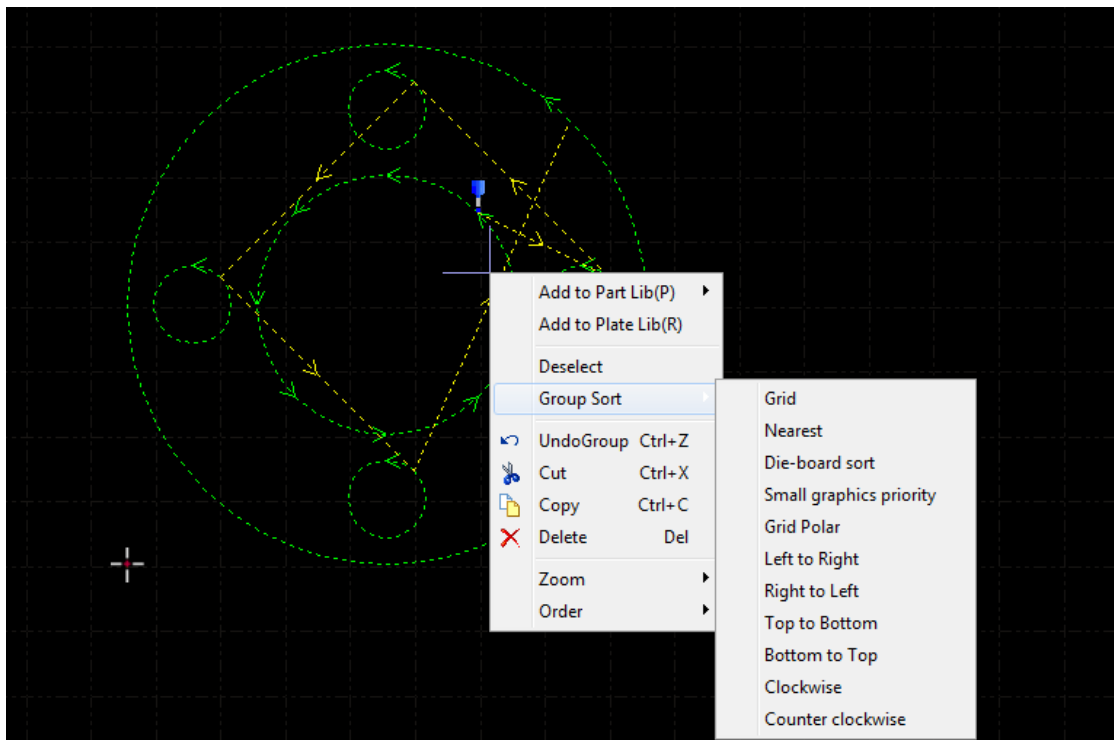



4. Machining control

CypCut integrates CAD and CAM functions, all operations including edit file and set cutting parameters can be done in the office or your own computer. Then you can open the file on machine for processing directly.

4.1 Coordinate System

Modeling coordinate designing graphic not relevant with the machine, zero point marked by . The coordinate referred in machining process and machine position are shown below:

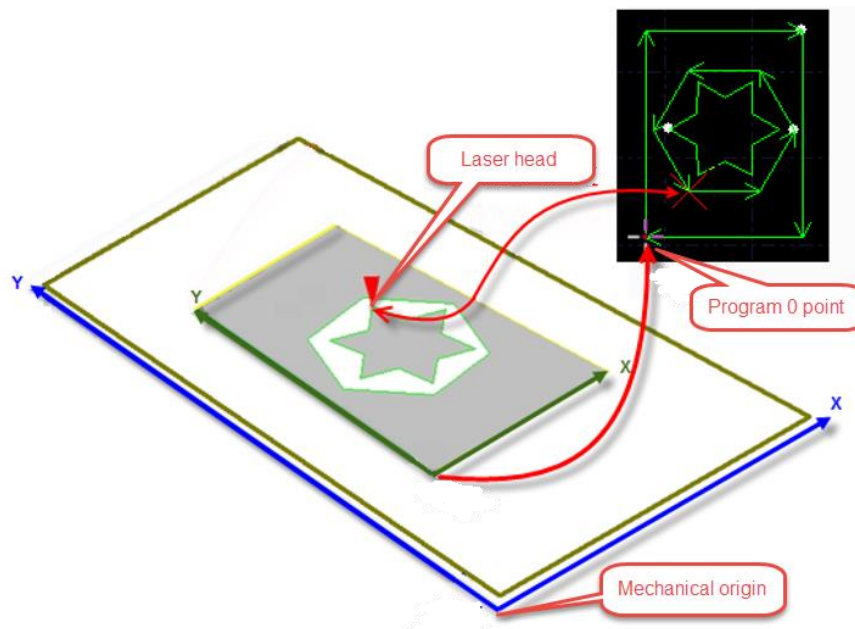

Click [Preview](#) in console will display the laser head position correspond with graphic.

4.1.1 Mechanical Coordinate System

Mechanical coordinate of the machine is defined by the mechanism. Coordinate

system is consistent every time execute return origin

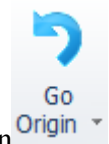



CypCut defines coordinates with same rules no matter what mechanism applied. Stand front of the laser head, laser head towards right is X+ direction, towards back is Y+ direction which means the left bottom is the minimum coordinate.

4.1.2 Program Coordinate System

Mechanical coordinate is consistent, CypCut also adopts workpiece coordinate. Workpiece coordinate X/Y direction same with

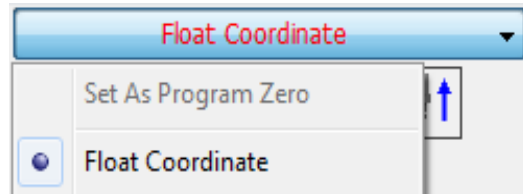

the mechanical coordinate system, only 0 point different and called **program 0 point**. Program coordinate system is divided into floating coordinate system and workpiece coordinate system.

Click the button above the console panel you can select 'Floating coordinate', 'Workpiece coordinate' or 'external coordinate'.

Floating coordinates used in cutting samples or small quantity parts. Laser head will start machining from current position.

If select **workpiece coordinate**, the zero point is manually set by users. Workpiece coordinate applied for large quantity production. This will assure machining starts from same position on the machine every time.

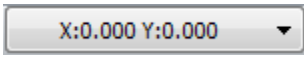
Click the status button  at bottom screen.

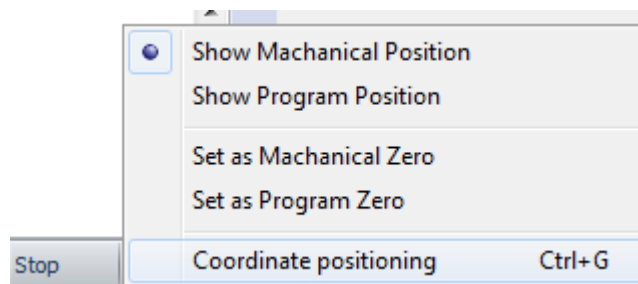

You can select to display mechanical coordinate or program coordinate and specify the zero point of the coordinate. Select 'coordinate positioning' will locate the cutting head to the specified coordinate position.

4.1.3 Find Zero Point after Interruption

Situation 1

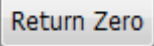

If machining process stopped by the accident but not affect coordinates, you can

click  return to zero point.

Situation 2

If accidents like power down or servo alarm stop the machining process and

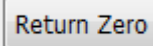
deviate the coordinates, must execute return origin then click  locate to zero point.

Situation 3

If the machining process interrupted by the accident or misoperation, you can still locate to the zero point of last machining process.

Click  in console panel and select 'remember zero' then click 'go record'.

Software version required: CypCut V731 and above.

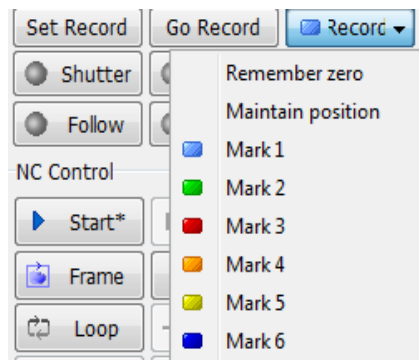

4.2 Alarm

CypCut monitors all components when machine running. Once monitored an alarm will stop the machining and display the alarm message in red title. Motion function will be disabled until the alarm removed. Check the alarm source and remove the alarm then resume the machining. The alarm title shown as below:

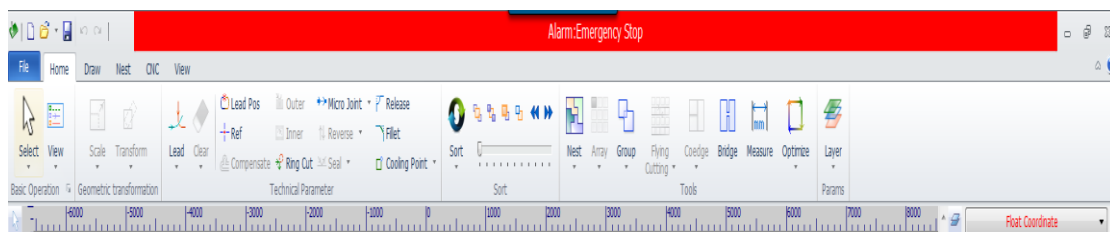

The 'Alarm' window at the screen bottom also display the alarm message. After remove the alarm source the alarm title will disappear but alarm message in alarm



window is recorded. Double click 'System' window can check all history records and software events.

Besides alarm CypCut will display the warning, notice and important message in different color once monitored abnormal process. These message won't stop the machining but still suggest notice these information and take precautions in advance.

The alarm can be automatically or manually removed. In 'Layer-Global parameter' window, at the right bottom there is option 'all alarm need reset manually'.

Below are restrictions once alarm activated:

- ❑ Disable servo when emergency stop alarm activated (prevent accident motion)
- ❑ Disable X/Y motion functions when BCS100 alarm detected (under this status, Z axis condition unknown, it might be collision if X/Y move)
- ❑ Disable XYZ motion function when emergency stop alarm activated (in complete stop status)
- ❑ Z limit- alarm, disable dryrun and jog.
- ❑ 'Move need confirm when BCS100 alarm'.

How to use :(Software version required: CypCut V731 and above)

1. In configuration tool-Alarm, select options 'BCS100 alarm must be acknowledged' and 'remove alarms manually'.

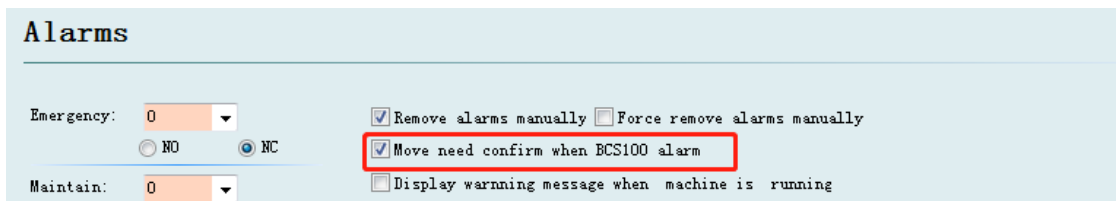

2. If BCS100 alarm activated, at bottom screen will display  and



, click



will allow motor function again.



报警信息	ID	状态	操作
切割头碰板	9		Help
切割头碰板	9	已解除	
切割头碰板	9	已解除	



允许轴运动





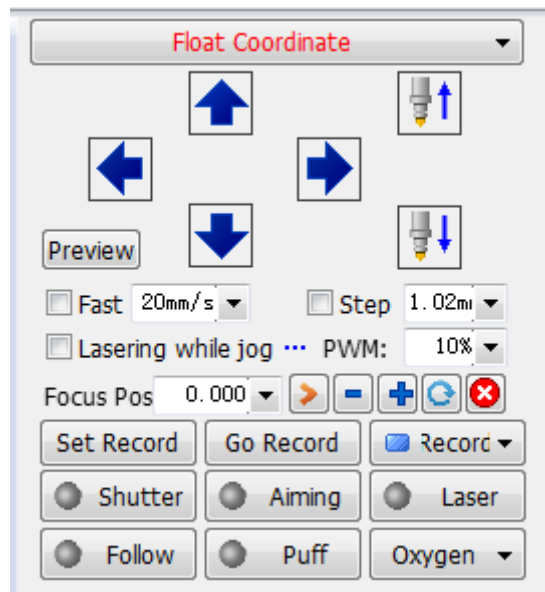

报警复位

4.3 Manual Test

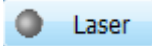
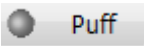
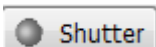

The function buttons in console panel as shown below:

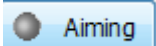

The button  will be in  once the function activated. Press  will emit laser, release button will close laser; for other buttons, click the button activate the function, click again close the function. For example, click  open the gas, click again close gas. For different laser model, there will be a delay click  till it turns to . This status accessed from laser unit. Click  will open guide/pilot laser.

Please take notice that each function realized by the related machine components. Without hardware or settings are not correct in config tool, the function button might not work.

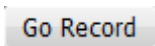

Click  to mark the current position, click  if you need to locate to the mark position. Users can record 6 marks in total select in .

4.4 Soft Limit Protection

CypCut provides software limit function. You can enable this function

 in console panel.

When the system detect motion area will exceed the preset limit, it will prompt message box to warn users and stop sending motion command to prevent collision.

Check the graphic one the drawing board make sure it's within the white frame.

System will monitor the current position in real time and stop the motor function once detected exceed the soft limit.

Notice: Soft limit protection relies on correct coordinates. Therefore, every time after change the machine config or system abnormal shut down happens users must execute return origin to correct coordinates.

4.5 Frame

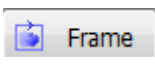
Click  laser head will move along the outline of the workpiece in a rectangle frame to help users identify the machining position and workpiece dimension on the plate. Frame speed is set in 'Layer-global parameter-frame speed'.

Notice: If the plate not up-right put on the machine bed and executed seek-edge operation, frame direction is also not up-right.

4.6 Start and Dry Run

Click  start machining, there will be monitor of machining process like coordinates, speed, time count and following height etc.

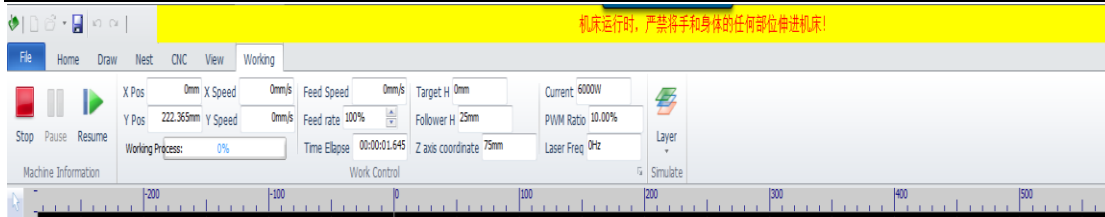

When in above status cannot switch to other pages only File menu is available.

If you need to modify the parameter in the machining process must pause the

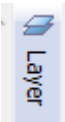
process then click the  button. Users can pause the machining and modify the parameters in layer window, settings will take effect after resume the process.

Supported version: CypCut V731 and above.

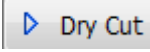
Click  laser head will move along the actual cutting path with same speed and acceleration but laser, gas and follow function turning off. Meanwhile other functions like pause, resume, forward, backward and break point information all same with the actual cutting. Dry run can used to check the machining process without cutting the plate.

If you want to open follow function in 'Dry run', select **Enable follow in dry cut** in layer parameter window-global parameter.

By default setting, laser head will return to zero point after finish machining. If you want laser head return to a specified position you can set on console panel including zero point, start point, end point, origin and mark point. If

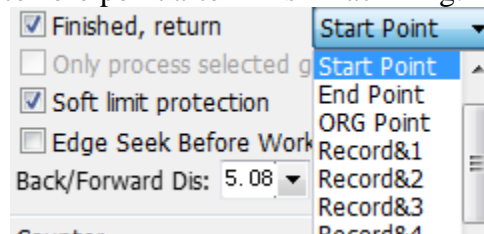



Finished, return not selected, laser head will stand still at where finish the machining. If you are using 'floating coordinate', it's recommended that select 'zero point'. If you want laser head return to a mark point, select 'record&'.

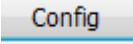
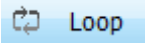

After a machining process completed it will add up 1 on 'Piece' at console panel. When the 'Piece' reach the 'Plan' times it will prompt message to remind user. You can set in  including target machining times and laser head actions after machining process completed. If you need to cycle the machining click  and finish the setting.

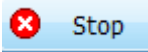
4.7 Stop, Pause and Continue

Click  or  on console panel will stop the machining. Stop the machining process, laser head will move to zero point. If you want laser head stand still cancel the option Return to Zero when stop on console panel.

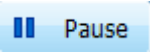
Click  or  on console panel can pause the machining process. Meanwhile you can modify the parameters in layer window, or execute the functions in console panel like burst laser, gas, turn on/off follow function etc.

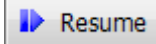
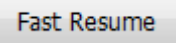
Click  in CNC tool bar or  on control panel to resume the machining process from interrupted position. Click  will resume the machining process directly without piercing.

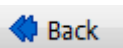
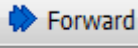
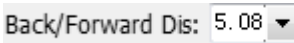
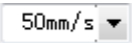
Click  or  to locate laser head backward or forward on the machining path. The distance and speed of one step set on   at control panel.

4.8 Breakpoint

When the machining process interrupted by accident like power down, as long as graphics and parameters related with machining process and sequence not been

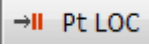
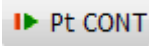

changed you can click  locate to the break point. Click  program will resume machining from break point.

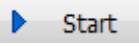
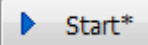
If you change the machining parameters,  button on control button will turn to , under this status break point function will be not available.

4.9 Start at Specified Position



CypCut allow users start machining from any position of the graphic. Right click on the graphic where you want to start machining and select

. As in the right picture:

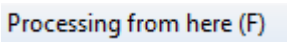
For safety concern, select

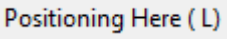
, program will prompt dialog box asks users to confirm operation. Then laser head will locate to the specified position first, then start machining.

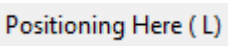
If select , laser head will locate to specified position then come in pause status.

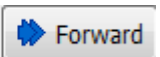
You can execute  multiple times. Or you can adjust start position by  .

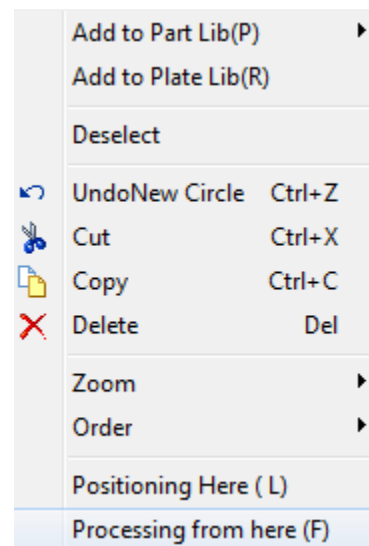

4.10 Global Parameter

The parameters setting in 'Global Parameter' window will affect the machine running condition, workpiece cutting performance and efficiency.

Below table lists part of the parameters.

Motion Control Parameters	
Move speed	Dry run speed (different from cutting speed).



Move acceleration	The max acceleration axis can reach in dry run.
Move Freq	The acceleration jerk of move acceleration.
Frame speed	Speed of frame-walk the workpiece outline.
Cut acceleration	The max speed axis can reach in cutting.
Work Freq	Acceleration jerk of cut acceleration in cutting.
Default setting	
PWM Freq	PWM signal frequency when burst laser.
Def Cur	The peak power when burst laser.
Def Pressure	Gas pressure when manual control the gas on console panel.
Gas delay	The gas delay in piercing process.
Initial gas delay	Extra delay when first time open gas after start-up the machine.
Switch gas delay	The time required to make sure old gas totally discharged and new gas comes in when switch the gas.
Cooling pt delay	The time of blowing gas at cooling point.
Back after stop	When resume the machining process from pause status, laser head will move back a distance.
Following parameter	
Max follow height	There is limit of follow distance between nozzle and plate surface. If the follow height larger than this value, Z axis will follow to this height then lift up to the target height. This parameter is used to set the maximum follow distance between nozzle and plate surface.
Frog style lift	Z axis moves in frog-jump style.
Enable follow in dry run	By default setting, Z axis not move in dry run. Select this option will open follow function in dry run.
Disable follow	Select this option follow function will turn off in machining process.
Only positioning	Applied in non-metal material cutting, select this option it will disable follow function in machining.



Unlift when move distance less than	If in layer setting select 'short move', when the dry run distance shorter than this value, Z axis will not lift and stay at cut height.
Unit switch	Select the unit system by user's habits.
Advanced	
Enable NURBS spline interpolation function.	Select the option can smooth the graphic curve and improve cutting speed.
Pierce and film setting	Set details in 3.13.3.
All alarms need reset manually	All alarms need to be reset manually
Enable machine protection	Hide some parameters which will affect the machine service life if set improperly.
Compensate precision	Precision of compensating cut seam.
Fly cut over distance	Extra cut distance at graphic end point. This will assure the whole graphic will be cut down.



5. CNC Assistant Function

5.1 Simulation

Users can simulate the cutting process check the cutting sequence in program. This process executed only in software, not sending any commands to the machine. By simulating the machining, users can check the sequence between parts and in parts.

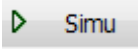
Click  in control panel, it will switch to 'CNC menu automatically, you can adjust simulating speed in tool bar.

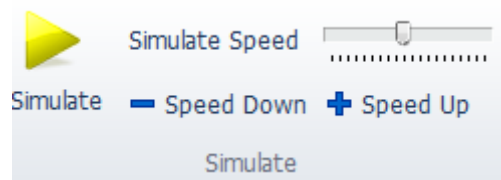

5.2 Find Edge

CypCut supports three patterns to find plate edge: BCS100 find edge, photoelectric sensor or manual locate edge. Click ' ' drop down menu you can select the find-edge pattern to locate plate position and edge. Find edge result will be displayed on the top right area of drawing board.

5.2.1 BCS100 Find Edge (Open in Platform Configuration Tool)



Edge
Seek ▾



Click  drop down menu select  BCS100 edge seek will open BCS100 find edge parameter window.

Plate size X is the plate length in machine X direction; plate size Y is the plate length in machine Y direction. The 2nd and 3rd point position to locate the plate edge



is calculated by the plate dimension, it's suggested that input value little smaller than actual dimension to avoid laser head crash in machine teeth.

Margin: Find edge result will determine a 0 point of plate. This margin can adjust the 0 point inward or outward the plate. If you have set plate margin in nesting plate then you can input 0 here.

6-point find edge: This recommended to use on thin plate. Laser head will execute 6 times find edge actions to reduce the interference of machine teeth.

'From starting point'-you can set a fixed position then find edge will start from this position every time. You can locate the laser head at a fit position as start point to find edge. This position must be within the plate.

'From current position'-laser head will start find edge from current position. Please make sure laser head is within the plate.

If select 'find edge before working', it will execute find edge before start machining.

Notice: Before execute find edge function, make sure laser head can follow to the material properly. The inclination angle of the plate should not exceed 10 degrees.

Find edge parameter window shown as below.



You can also set more detailed actions click bottom button

Detailed parameters

Parameter	Value	Unit
Seek Speed	100	mm/s
Follow Height	4	mm
Adjusted Value(X)	10	mm
Adjusted Value(Y)	10	mm
Rack Dif	30	mm

Find edge speed affects the accuracy of result, recommended 100mm/s;

'Follow height' is distance between nozzle and plate in find edge process, recommended 4mm;

'Adjust value' is to offset the find edge result inward or outward the plate;

'Rack dif' is the **gab between machine teeth tip**.

5.2.2 Infrared find edge (photoelectric sensor, open in platform configuration tool)

The photoelectric sensor support Omron E3Z-L61.

If use infrared find edge function first time, measure the horizontal distance between sensor and laser beam. Before execute find edge, locate laser head to the start position (top left, bottom left, top right or bottom right).

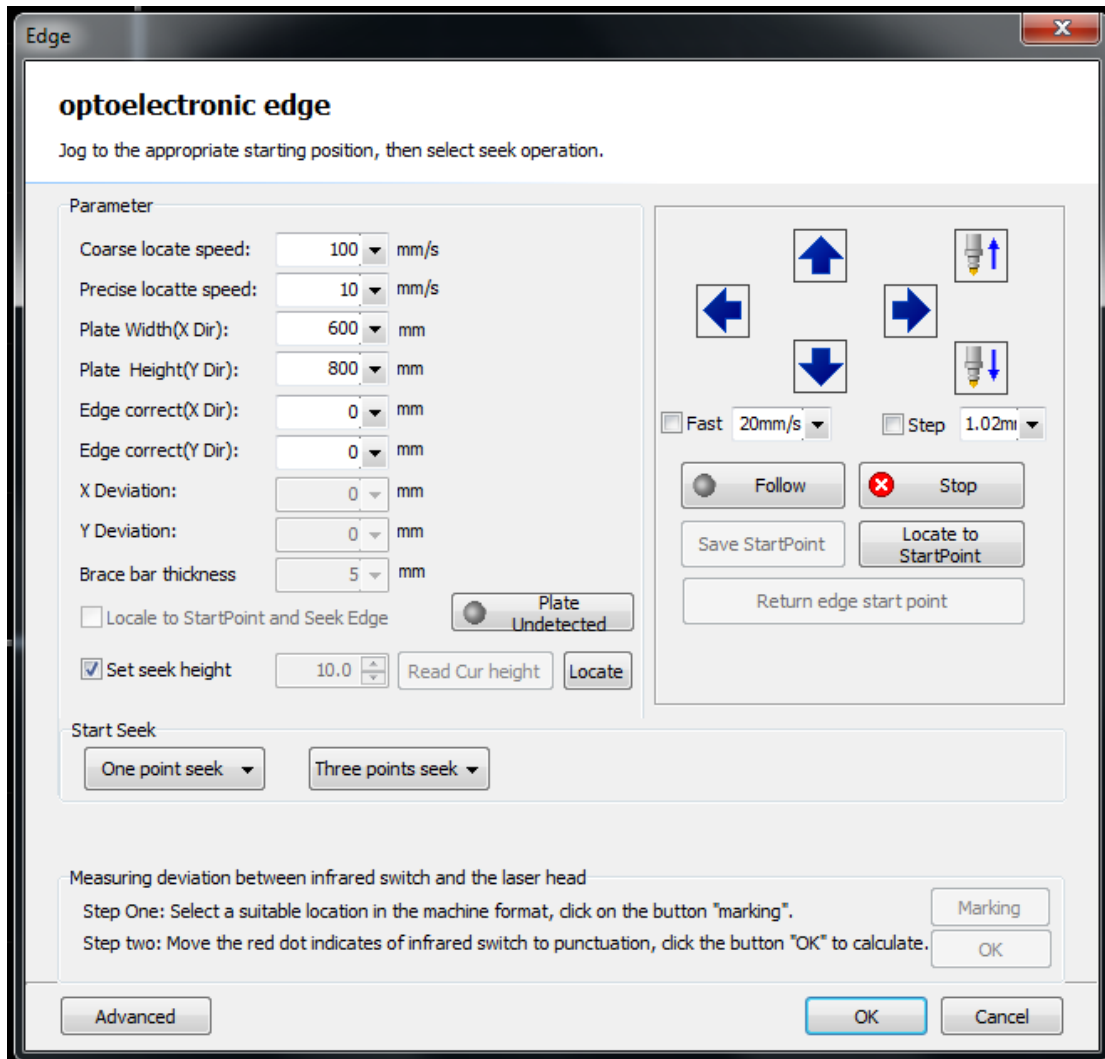

It's required parameter setting to start this function. The coarse locate speed is recommended 100mm/s; Precise locate speed will affect the accuracy of result, recommended 10mm/s and no more than 30mm/s. Locate the edge with slower speed will get more precise edge result. Plate dimension and 'edge correction X/Y' same with BCS100 find edge setting.

Advanced settings will reduce the machine tooth tip interference and offset between sensor and laser beam.

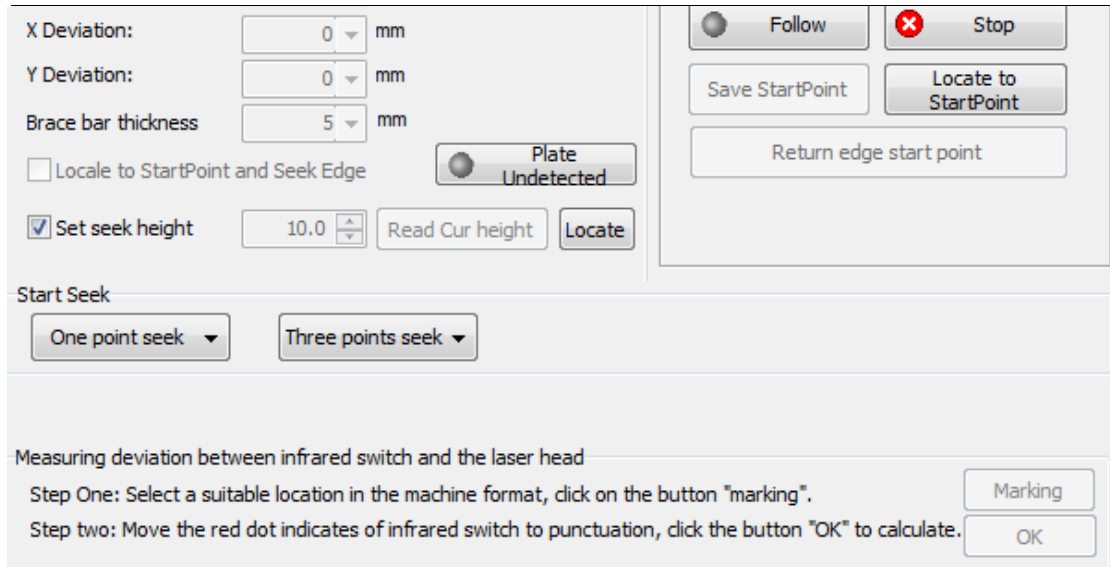

You can set the following parameters ‘Y deviation’ is the horizontal distance between sensor switch and laser beam accessed by program automatically; ‘Brace bar thickness’ (tooth thickness) reduce the machine tooth effect to the sensor; ‘Seek height’ used under scenario that sensor switch mounted on the laser head. Users can jog Z axis up or down to adjust the sensor position and set as ‘seek height’. Each time start find edge it will locate to this position.

Notice: The inclination angle of the steel plate should not exceed 40 degrees.

5.2.3 Cut Off (open in platform configuration tool)

Open this function it will show options under ‘Seek edge’ drop down menu. This function used to split plate.

Cut off safe distance: Laser head starts from outside plate in a fixed height after pass this distance will follow to plate.

X cut off (left to right): Select this option when execute split-plate function, laser head will follow out of the plate then cut in from left side, then follow out of the plate cut in from right side.

Notice: When split plate it should use parameter of green layer.

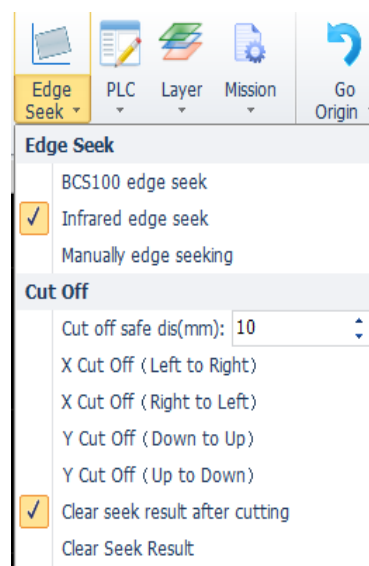



5.3 PLC Process

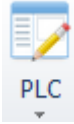

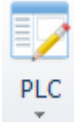
Click  in 'CNC' menu users can edit and execute PLC process.

Notice: Inappropriate PLC settings can lead to serious consequences! Please contact our technicians if you have any doubt.

5.4 Return Origin Point

5.4.1 Return to Mechanical Origin

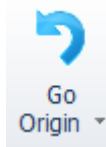

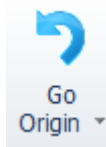
You can click  in CNC menu to return axes to mechanical origin and rebuild coordinate. See details in section 'coordinates'. Click X Only or Y Only axis will return origin separately. If you select Follower first or Follower first program will execute the actions when return axes to origin.

5.4.2 Gantry Synchronization

For the machine with gantry design, some problems like two Y axes not mounted parallel, friction or load different, will cause gantry position error affects cutting precision. System will record the Y1/Y2 Z-signal position at mechanical origin, then offset the Y axes position error.

Click Go origin drop down menu and select **Gantry initialization**.

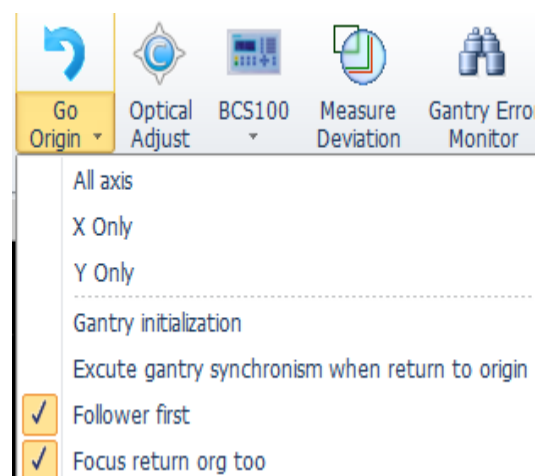



After finish gantry synchronization select the option

Excute gantry synchronism when return to origin .The offset message will show in system window at bottom screen.

Notice: Once modified the machine structure it must execute gantry synchronization again.

Details of operation see in appendix.

5.5 Optical Path Setting

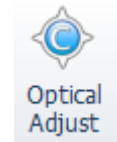

If you need to locate laser head to a specific position, click in CNC

X: 143.86mr

Y: 143.86mr

Locate

menu and input coordinates in

CypCut can also assist interferometer to measure the mechanism offset.

5.6 Diagnosis Window



Diagnosis

Users can click to check all signal status in machining process to debug.

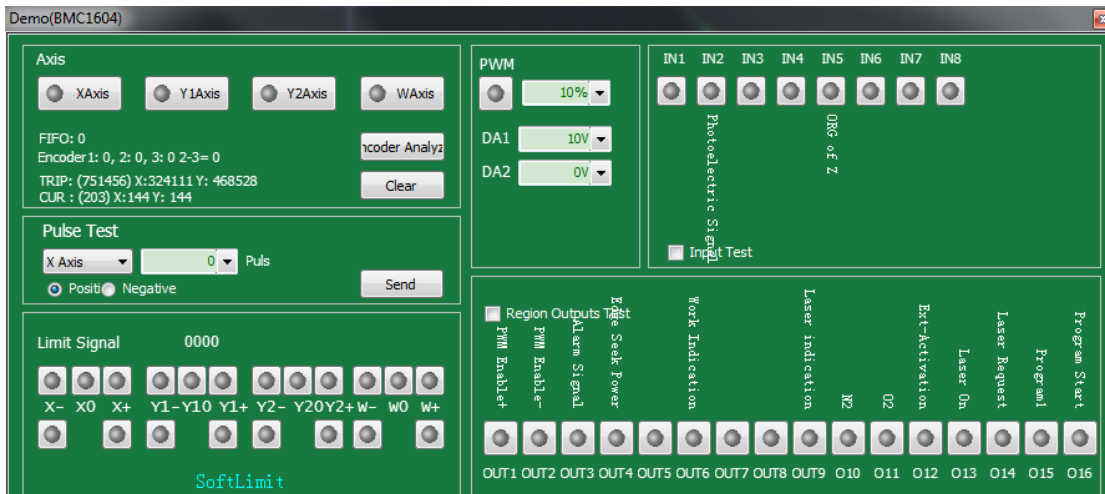

It also monitors signals of each axis and encoder feedback. Users can send pulses to any of these 4 axis and check if pulse equivalent set right by comparing encoder



feedback. Limit signal activated means laser head hit limit switch or other situation trigger the limit sensor. PWM monitors laser status of turning on or off. It also monitors signal terminal status of 15 inputs and 20 outputs.

'Encoder analysis' can check if encoder feedback same with the motor rotation. Some functions require consistency of the encoder feedback and motor rotation.

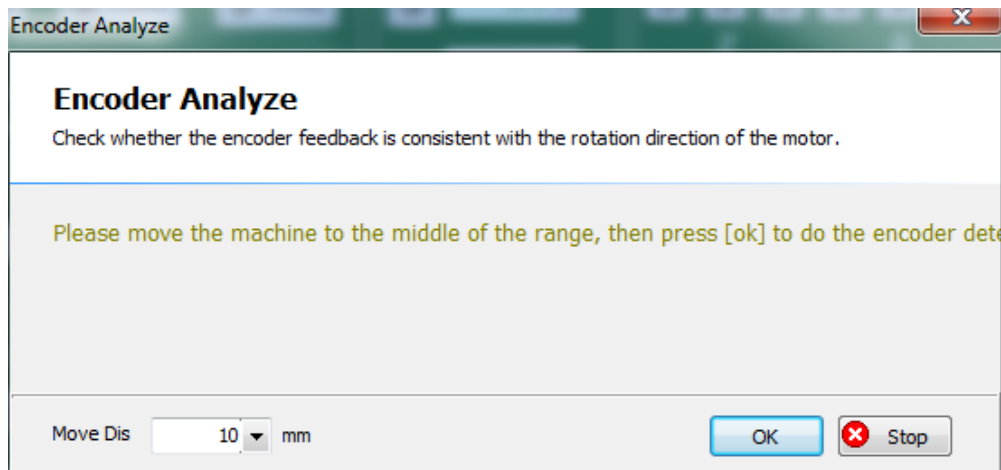

5.7 BCS100

This function requires BCS100 controller. Users can control BCS100 controller in CypCut software in  including return axis to origin, follow to plate, locate axis to specified position and calibration etc. Users can also do BCS100 settings through software.

5.8 QCW

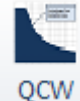
QCW is a laser working mode. Laser working mode contains CW and QCW. CW is continuous wave and QCW is pulsing type. Click  to set the parameters related this laser mode.



5.9 Measure Deviation

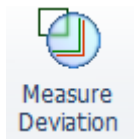

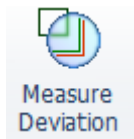
Click  laser head will run through the graphic. Then program will display a dotted line in blue calculated by the motor feedback. Users can compare the reference path with the feedback path to adjust the related parameters to reduce deviation.

5.10 Clean Nozzle (open in config tool)

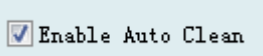
Open the function in config tool-auto clean  it will show in CypCut-CNC column 'Clean nozzle' function button.

Instructions:

Jog laser head to brush and set Z position (nozzle should be on the brush).

Users can select if blow gas when clean nozzle.

Laser head can move in straight line, circle or wave pattern to clean nozzle.

Select the pattern in 'adjust setting' .After finish the setting click 'Ok' will start clean nozzle.



Auto Clean

Auto Clean Nozzle

Move the cutting head to the position of nozzle cleaning and clean it.
Notice:Soft Limit is closed temporarily when Performing a cleaning nozzle

Z Axis

100

Z Axis return to ORG befo

Gas

Gas when Cle Puff

Clean Gas

Clean Pressure BAR

Fast Step

Set Curve

(0.00,0.00)

Return after done

Speed of Operatio

Operation Count

Direction of Line

Length of Line



6. Appendix

6.1 Co-edge Example

Below is a real example of a customer's part graphic setting co-edge. The original DXF is on the right side.

The graphic in red line is unclosed created in CAD.

You can briefly tell that there are 6 bigger parts and 10 long strip parts at bottom and $9 \times 2 = 18$ short strip parts at right side.

First, separate these 3 parts .As shown below:

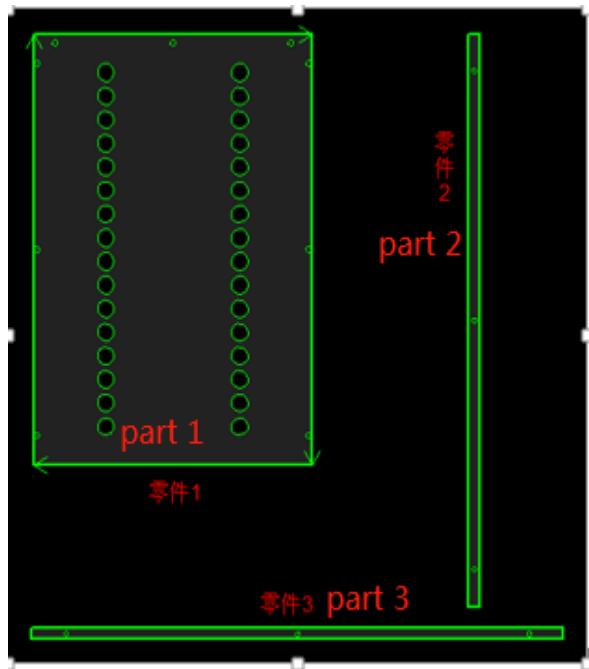

Then group the graphic as three single parts.

Select part 1 array in 3×2 pattern.

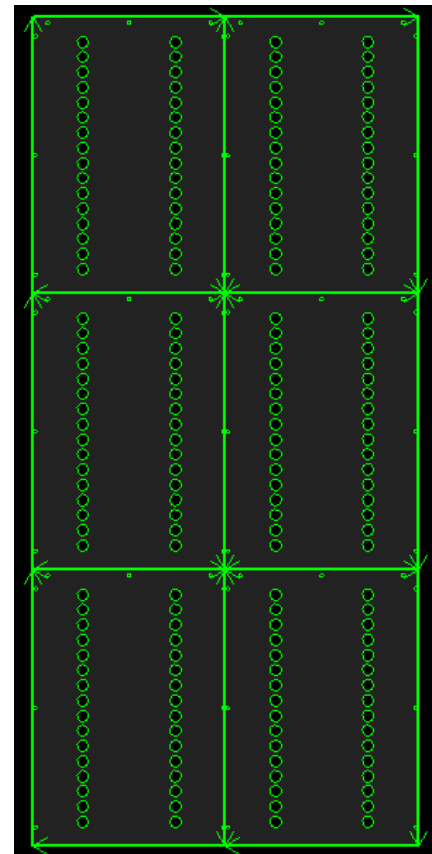
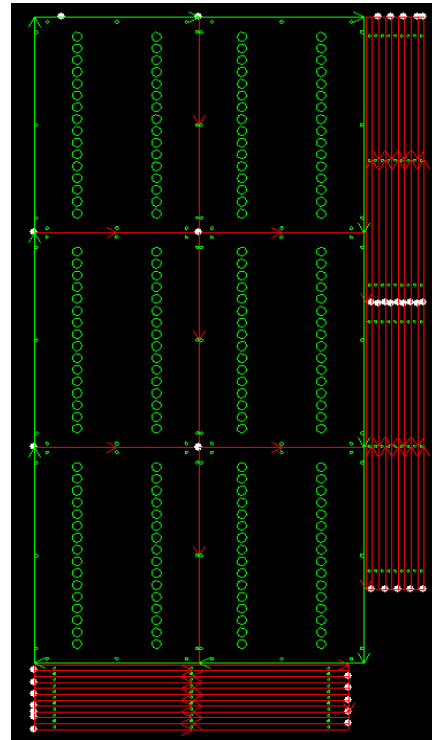



Select the arrayed parts and click  will finish the co-edge of these 6 parts.

Select part 2 close to part 1, it will attach to the part 1. As shown below:

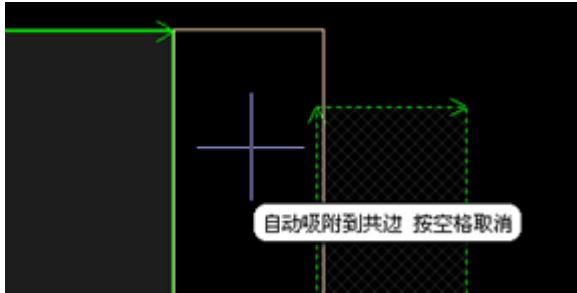

Select part 2 array by 2*9 will get the result as in right picture.

Select these 18 parts.

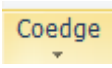
Click  will finish the co-edge of part 2. The cut sequence of part 2 must from right side to the left side, otherwise the workpiece will

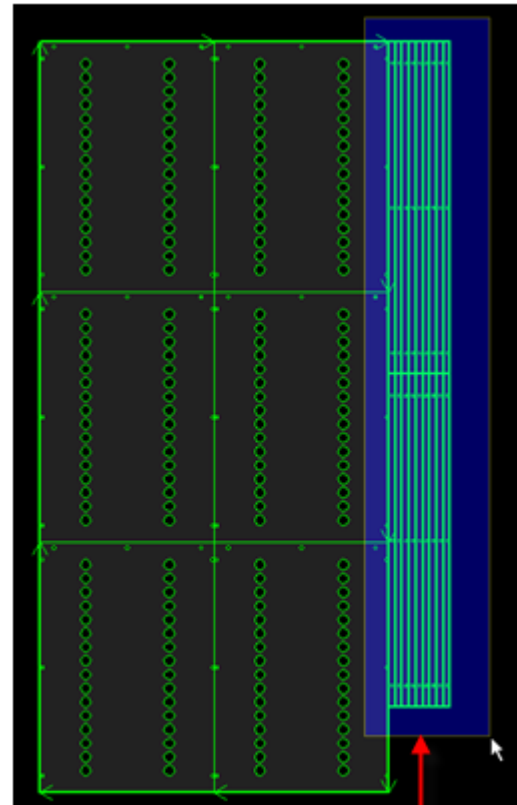
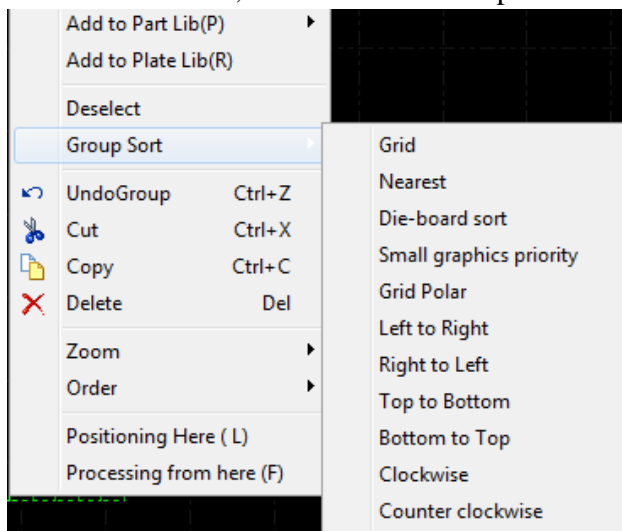

要求从右向左加工

deviate for lack of holding force.

Right click part 2 select 'group sort-right to left'. As shown below:

You might be curious about

why attach the part 2 with part 1 then co-edge the part 2.

The order can be switched. Next we will co-edge part 3 then attach the part 3 to part 1.

Select part 3 and array by 10*1 then we get below result:

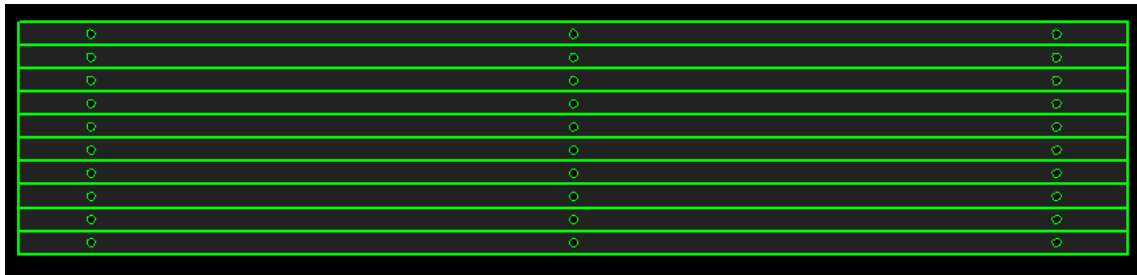

Select all part 3 click ' ' will co-edge part 3.As shown below. Take notice that co-edge part outline is different. After finish the co-edge of all parts, the frame of whole object shown in bolder line.

When the cursor point on the graphic it will show the message indicates it's a group.

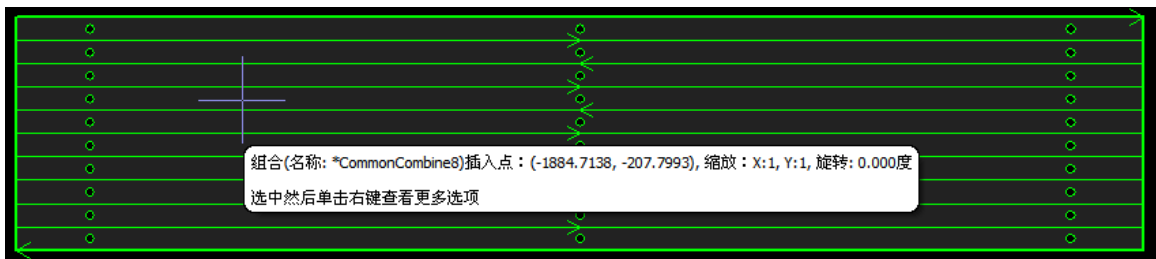

Cut sequence of part 3 also should be from bottom to top.

Select part 3 attach to part 1.As below:

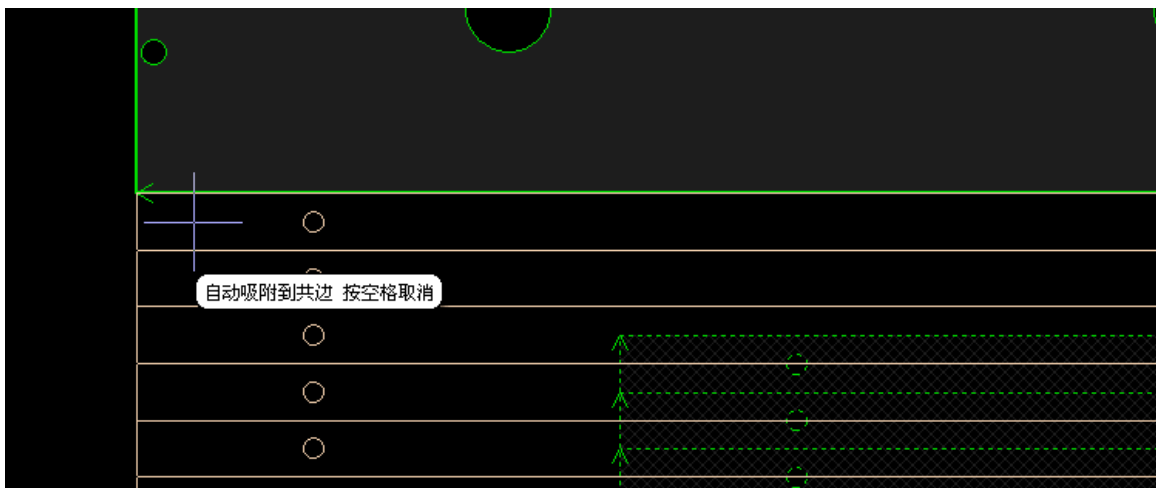

Then you can co-edge all parts.

If you don't need part 1/2/3 co-edge then pass this step.

6.2 Gantry Synchronization



6.2.1 Platform Configuration

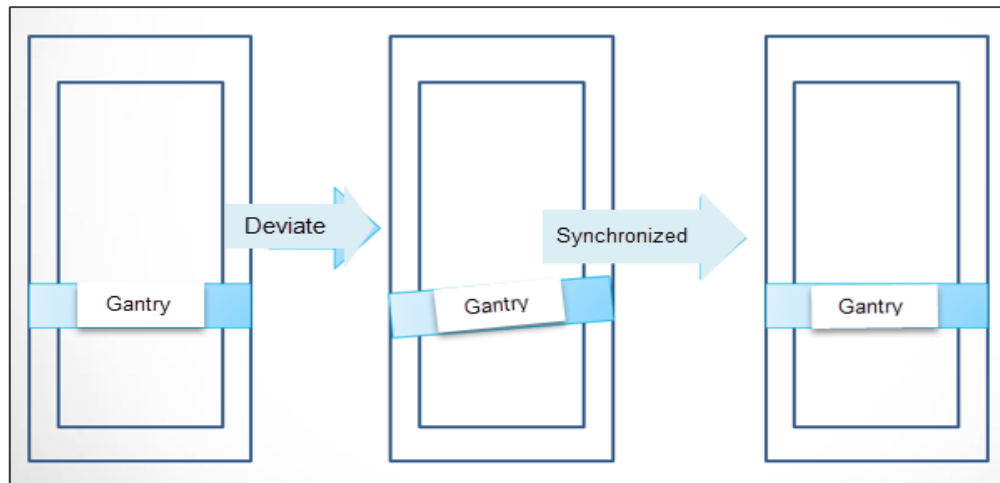

Gantry synchronization function should be open in config tool 🌱.

- 1) Platform config tool -> Machine -> select 'Dual drive'

Mechanism

X Axis

ServoAlarm NO NC

Range Move need pulse

Max Speed Max Acc

Y Axis

Dual Drive ServoAlarm NO NC

Range Move need pulse

Max Speed Max Acc

- 2) Platform config tool -> Return origin -> select 'Z signal'

Return Org

Soft limit Prompt go Org at start Prompt go Org in warning

X ORG direction: Neg Pos Y ORG direction: Neg Pos

ORG signal: Org Limit Limit logic:

Z-Phase signal: Enable



2) Platform config tool -> Alarm -> input "gantry deviation tolerance".

When the gantry deviated by crash or other reason exceed this value you should check the machine parts. You can set the value as needed.

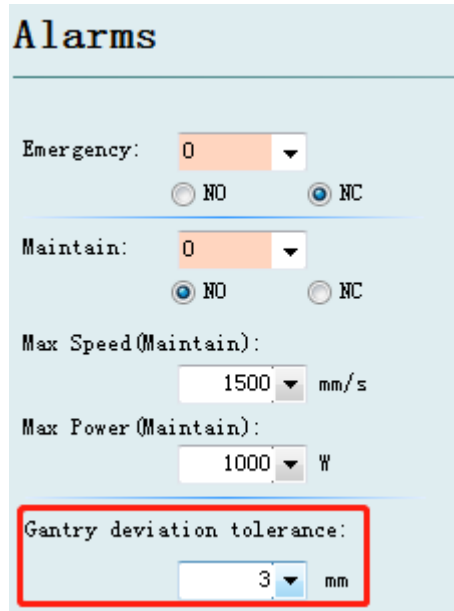

6.2.2 Gantry Initialization and Synchronization

Before start gantry initialization, please confirm that following items:

1. The gantry is been corrected deviation.
2. Axes motor functioned normally.
3. Origin switch works normally.
4. Z-phase signal pin wiring correctly.
5. Encoder feedback pulse set right. You can check pulse feedback in diagnosis

window-card monitor.

Open CypCut main program, in CNC-Return Origin

drop down menu, click **Gantry initialization**.

It will execute return axes to origin, then get Z phase signal of Y1/Y2 axis. After return origin, it will show Z phase signal difference (Y2-Y1 offset) at bottom screen.

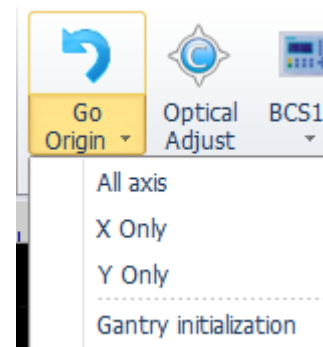



```
(09/29 10:52:07)回原点
(09/29 10:52:07)回原点2
(09/29 10:52:13)Y1_1 z coordinate is:-64554
(09/29 10:52:13)Y1_2 z coordinate is:-54554
(09/29 10:52:13)Y2_1 z coordinate is:-61846
(09/29 10:52:13)Y2_2 z coordinate is:-51847
(09/29 10:52:13)Y2-Y1offset is:2708
```

Z-phase signal difference. Unit: pulses

After finish gantry initialization, select `Excute gantry synchronism when return to origin` input password and save the setting.

Then every time execute 'Return origin' or 'Y return origin' system will compare Z signal position difference and add offset. The details will show in system window at bottom screen.

```
绘图 系统 报警
(09/29 10:53:48)回原点
(09/29 10:53:48)回原点0
(09/29 10:53:52)Y1_1 z coordinate is:-10001
(09/29 10:53:52)Y1_2 z coordinate is:-1
(09/29 10:53:52)Y2_1 z coordinate is:-7293
(09/29 10:53:52)Y2_2 z coordinate is:2707
(09/29 10:53:52)Y2 compensate 0mm
```

Offset value 单位: mm

6.2.3 Notice

1. This function requires Z phase signal.
2. Once machine structure modified, must execute gantry initialization.
3. When the gantry deviated visibly from big mechanical shock, you have to adjust the gantry mechanism and execute gantry initialization.

6.3 BCS100 Find Edge Instructions

CypCut6.3.712 and above improve the find edge function in precision of locating plate edge. This requires BCS100 V3.0.3299 and above. BCS100 V2.0 doesn't support new function.

6.3.1 Platform Configuration

Open config tool, enter find edge page and select Enable BCS100 Seek .

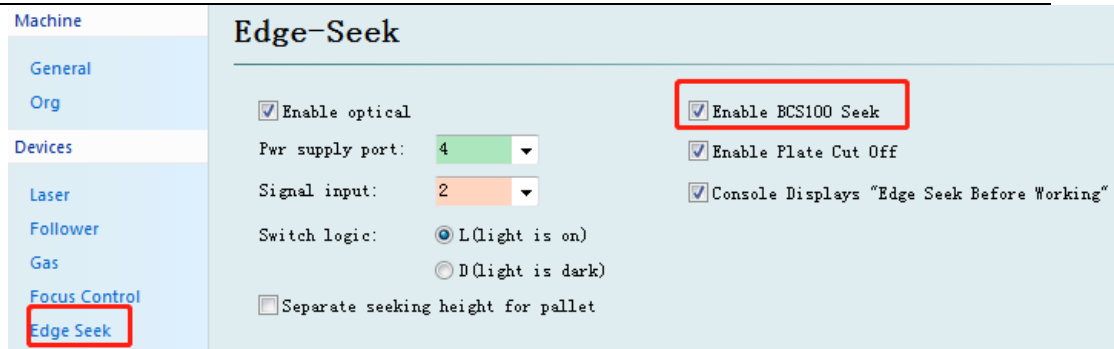

6.3.2 Single Point Find Edge

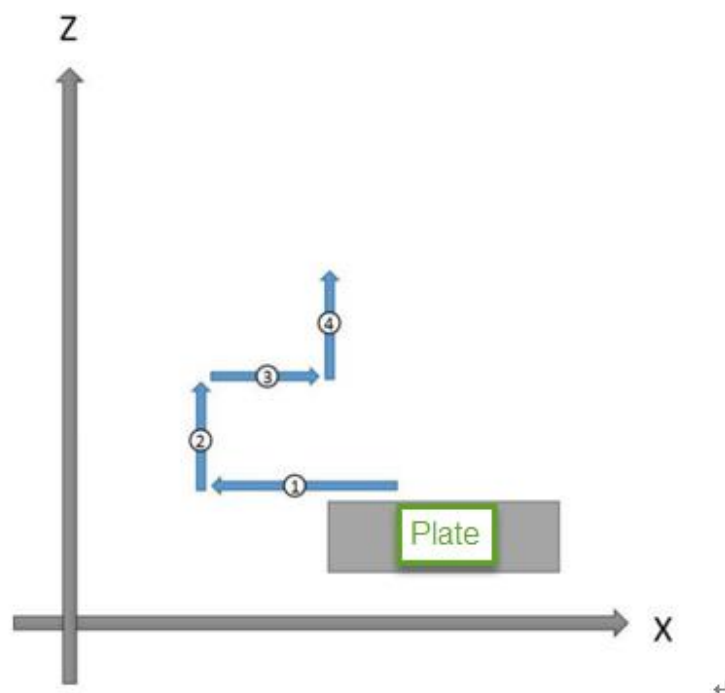

For example if select left direction:

- 1) Laser follows to plate and starts find edge in left direction.
- 2) Laser head lifts up.
- 3) Laser head returns back in right direction and stop at plate edge.
- 4) Laser head lift up and stops at dock position.
- 5) Find edge process complete.



6.3.3 Three-Point Find Edge

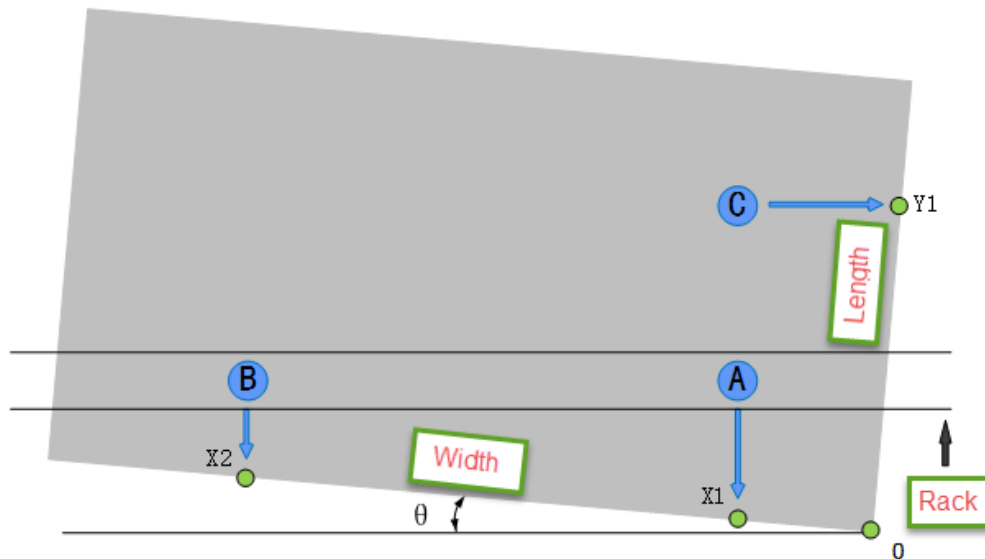

Here is an example that reference point is at bottom right.

- 1) Input plate dimension. The plate dimension should be same or little smaller than the real plate.
- 2) Locate the laser head to the bottom right on the plate.
- 3) The program will get position A/B/C by the current position and plate dimension.
- 4) Laser head will move in Y- direction and get X1;
- 5) Laser head will moves to B;
- 6) Laser head will move in Y- and get X2;
- 7) Laser head moves to C;
- 8) Laser head moves in X+ direction and get Y1;
- 9) After program finishes find edge process, it will calculates angle θ and define 0 point at bottom right corner of plate. Laser head will locate to the 0 point.

6.3.4 BCS100 Find Edge Notices

1. Before start BCS100 find edge function, it must execute return axes to mechanical origin to build correct coordinate.



2. Open CypCut-Diagnosis-Card monitor check the encoder feedback that must be same with command pulses.
3. Plate dimension setting should be same with the real dimension.
4. The inclination angle of the steel plate should not exceed 10 degrees.
5. Before start find edge, it should set reference point as top left, top right, bottom left or bottom right, otherwise it's not available for find edge function. Reference point defines the direction that laser head starts to find plate edge.
6. You have to locate laser head within the plate before start find edge function.
7. You have to make sure laser head can properly follow to the plate.

6.4 Infrared Find Edge

CypCut V6.3.642.6 and above support find edge by photoelectric sensor. The photoelectric sensor support Omron E3Z-L61.

6.4.1 Photoelectric Switch

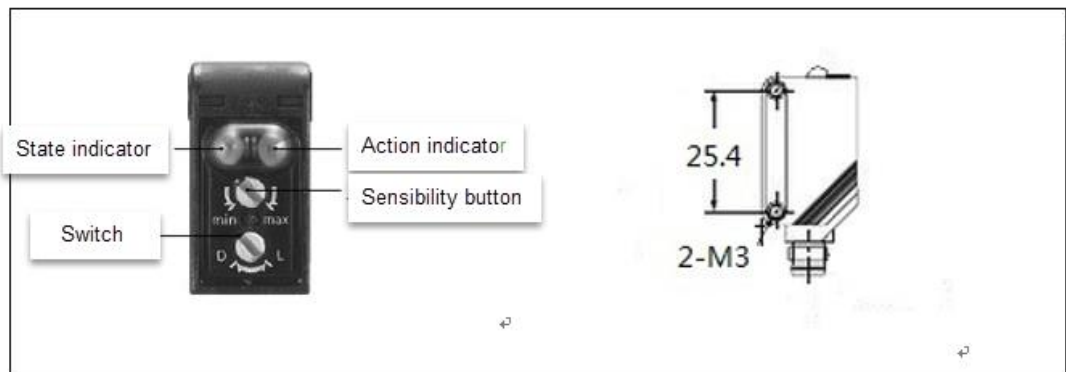

The effective working range of the photoelectric switch is 90 +30 mm.

Installation thread is M3; the switch can switch into 2 modes. Switch to L lights on when outputs signal, and switch to D lights off when outputs signal. Spin button can adjust the sensitivity of the switch.



6.4.2 Wiring and Configuration

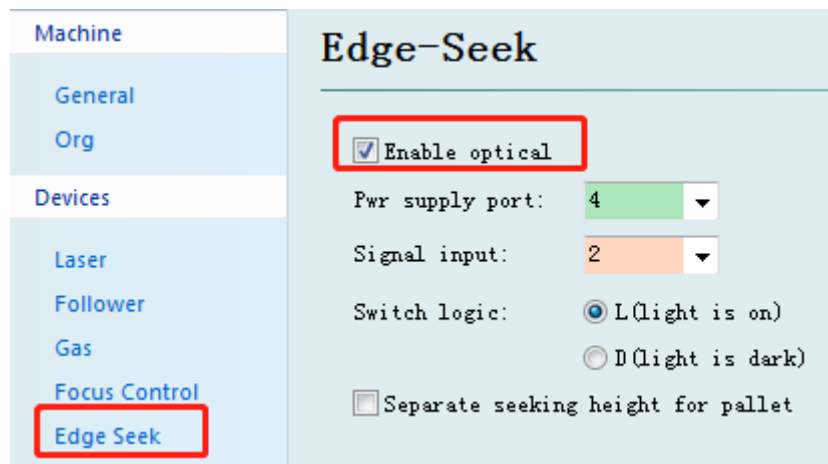

Open the config tool and click into 'Find edge' page on the left sidebar. Select 'enable optical'.

The 24V+ power line of brown connected to the thyristor output terminal on IO board, 24V- power line of blue connected to the COM terminal on IO board, black line connected to input terminal on IO board.

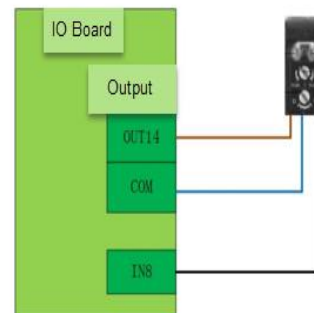

The signal logic of switch must be consistent in CypCut config tool and actual mode of switch. L mode is recommended.

If the machine mounted with exchange table also select 'separate seeking height for pallet'.



6.4.3 Three-point Find Edge

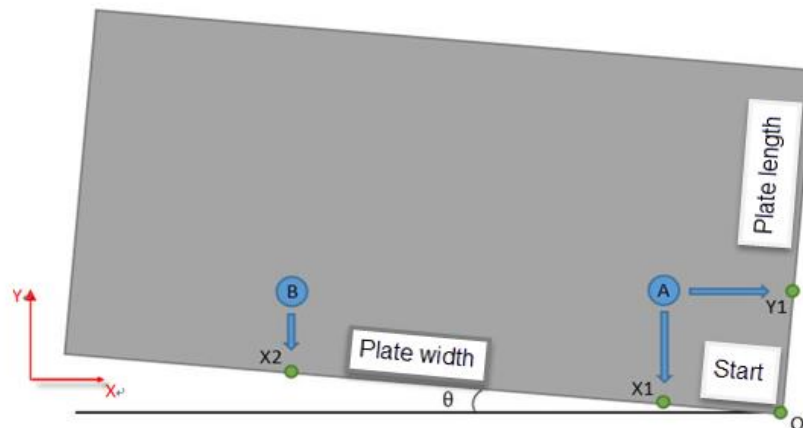

- 1) The first time use 3-point find edge function you have to measure the offset in horizontal direction between switch and laser head center;
- 2) Open the guide laser and locate the laser head at bottom right on the plate;
- 3) Select 'bottom right' under 3-point find edge drop down menu;
- 4) Acquire point A and point B by the plate length and width;
- 5) Locate to point A;
- 6) Find edge in Y- direction and get X1;
- 7) Locate to point B;
- 8) Find edge in Y- direction and get X2;
- 9) Locate to point A;
- 10) Find edge in X+ direction and get Y1;
- 11) Find edge process complete, program will calculate plate inclination degree θ , and laser head will locate to O point on the bottom right plate;

6.4.4 Precautions

- 1) Open CypCut-Diagnosis-Card monitor check the encoder feedback that it must same with command pulses.
- 2) When you adjust the switch sensitivity make sure the green indicator always turns on.



- 3) The setting values of plate length and width are consistent with the actual dimension.
- 4) The inclination angle of the steel plate should not exceed 40 degrees.
- 5) In test page it's available to customize a find edge position. But in actual practice it must to set the reference position as top left, bottom left, top right or bottom right so program can identify the find edge direction.
- 6) The first time use 3-point find edge function you have to measure the offset in horizontal direction between switch and laser head center.
- 7) When execute find edge, you have to locate the guide laser within plate.

6.5 Regional Output

In CypCut config tool- Outport page you can set regional output for dusting. Select 'Area output' set the lines and columns. Drag the boundary line can change the area of each zone. You can assign output to each zone.

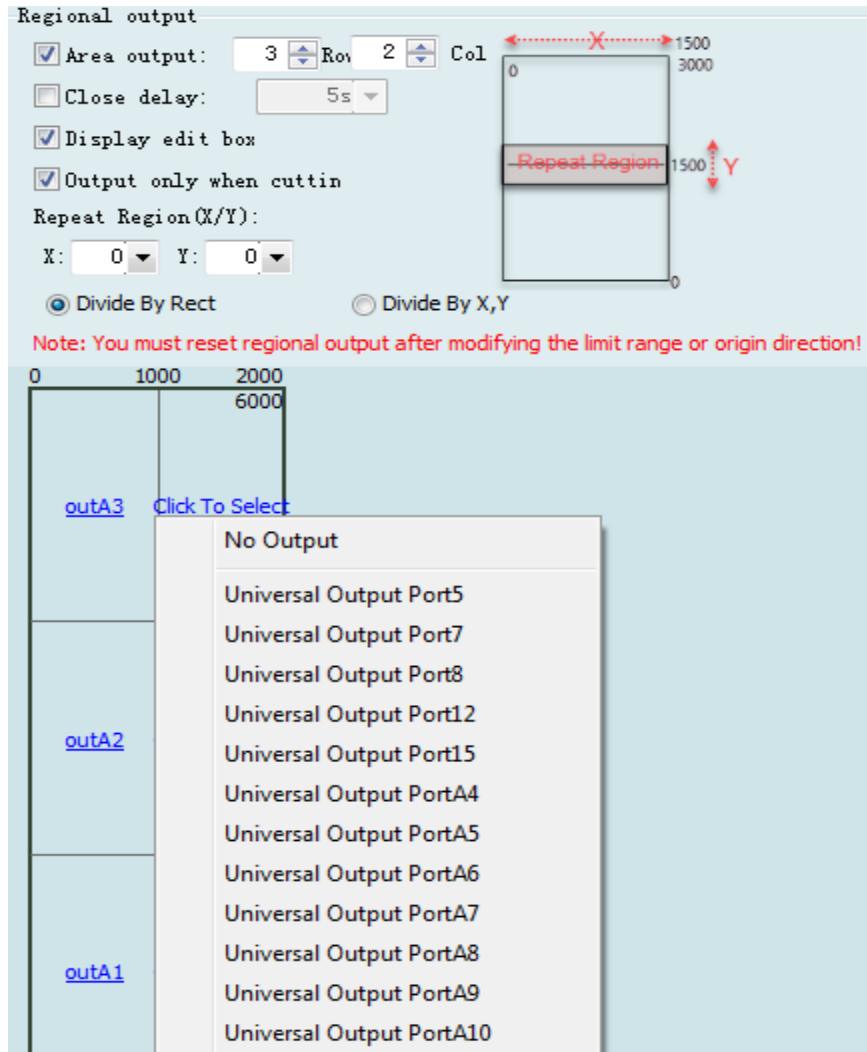

6.6 Motion Parameter Adjustment

6.6.1 Motion Control Parameter

CypCut opens motion control parameters including speed, acceleration, low-pass filter, corner and curve precision etc., to users. Other parameters related with motion performance has been optimized automatically. The description of parameter is shown in the following table:

Name	Description
Move speed	The max dry run speed. You can set this value according the result calculated by the ServoTool.



Move acceleration	The max dry run acceleration. You can set this value according the result calculated by the ServoTool.
Cut acceleration	Maximum cutting acceleration directly determines the time required of ACC/DEC in corner motion. You can adjust this value by observing servo torque curve.
Low-pass filter frequency	Smaller value will improve the vibration suppression but extend the ACC/DEC time.
Curve precision	The max precision in curve machining. The lower the value is, more obvious in speed limit at curve machining.
Corner precision	The precision of NURBS curve fitting the corner path. The lower the value is, corner path will be sharper and speed reduction more obvious.

6.6.2 Cut Acceleration

Jog axis at a high speed, 500mm/s for example, make sure axis move a long distance and reach the set speed.

Monitor the torque curve in servo tool when jog the axis, increase the work acceleration if peak torque under 80% or reduce work acceleration if peak torque larger than 80%.

Adjust the acceleration until top torque reaches to 80%.The acceleration lead screw structure can bear is usually no more than 0.5G.The acceleration gear rack structure can bear is no more than 2G.

6.6.3 Move Acceleration

You can set this value according the result calculated by the ServoTool. Or larger than work acceleration by 1.5~2 times of it. When axis running without load, servo torque should be within 150%, and there is no mechanical deformation and vibration



under this acceleration. The acceleration lead screw can bear usually no more than 0.5G. And usually no more than 2G for rack gear structure.

6.6.4 Low Pass Frequency

Adjust low-pass filter by cutting a workpiece sample. Set a small laser power marking on plate and observe the cutting path. The sample graphic could be small circle in different sizes, hexagon, dodecagon, star shape and rectangle. As shown in the following figure:

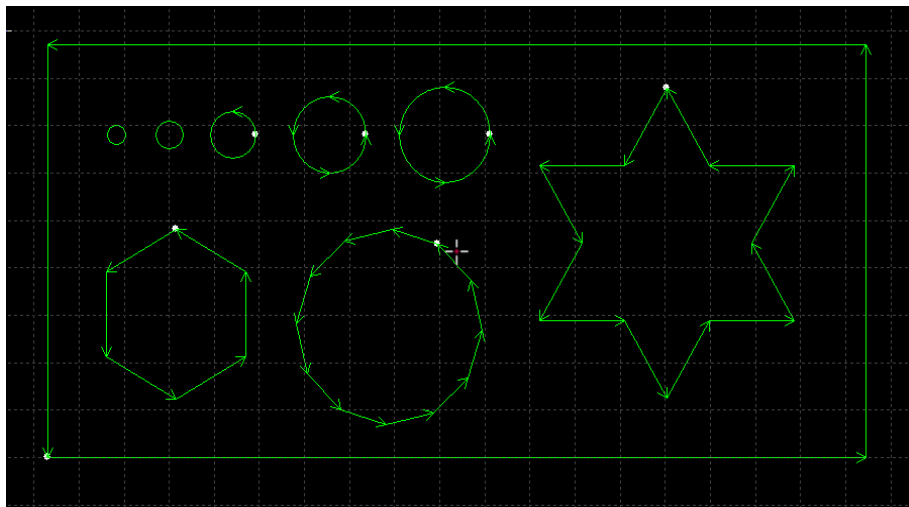

Increase the low pass filter as much as possible without affecting the cutting precision. The reference standard of test cutting is no waves around the corner in rectangular, star type cutting. You can setup as the experiential value in below table. Or you can setup the cutting acceleration then adjust the low pass filter frequency up and down within 2 levels. The cut acceleration and low pass filter frequency must match, does not setup a large value and the other too small.

Level	1	2	3	4	5	6	7	8	9	10
Cut Acceleration (G)	0.1	0.2	0.3	0.4	0.5	0.6	0.8	1	1.5	2
Work frequency (HZ)	3	3.5	4	5	5.5	6	6	6	7	8



6.6.5 Arc and Corner Precision

Only under special circumstances to adjust the parameters in a small extent around the default value, otherwise not recommend to modify these two parameters.

If curve precision parameter set too large and cutting precision is not good, you can lower the curve precision which will limit the cutting speed at curves. If sharp corner precision is not good, lower the corner precision will limit the cutting speed at sharp corner. The value set too large the sharp corner will turns to a round corner.

6.7 Shortcut Key

The following table lists the shortcuts commonly used in CypCut, some of which need to be used in specific circumstances. They have been introduced in relevant chapters, and are not listed here.

Shortcut Key	Effect	Using conditions
Ctrl + A	Select all graphics	None
Ctrl + C	Copy graphics to clipboard	Select the graphics to operate on
Ctrl + Shift + C	Specify baseline copy command	Select the graphics to operate on
Ctrl + O	Open file:	None
Ctrl + P	Display/Hide graphic direction and move path	None
Ctrl + V	Paste clipboard graphics to drawing board	There are copied graphics in the clipboard
Ctrl + W	Adapt the window	None
Ctrl + X	Cut graphics to Windows clipboard	Select the graphics to operate on
Ctrl + Y	Redo the order just revoked	There are revoked orders
Ctrl + Z	Revoke the order just completed	There are completed commands
F2	Open the Layer parameter window	None
F3	View all graphics	None
F4	View the whole range of machine tools	None



Shortcut Key	Effect	Using conditions
F7	Display/Hide machining path	None
F8	Display/Hide move path	None
DEL (delete)	Delete selected graphics	Select the graphics to operate on
SPACE (Space)	Repeat the previous command	The last command is repeatable

6.8 Burn Test

Newly installed machine required aging test to confirm the running performance. How to open this function: File - > Diagnose - > Burn test

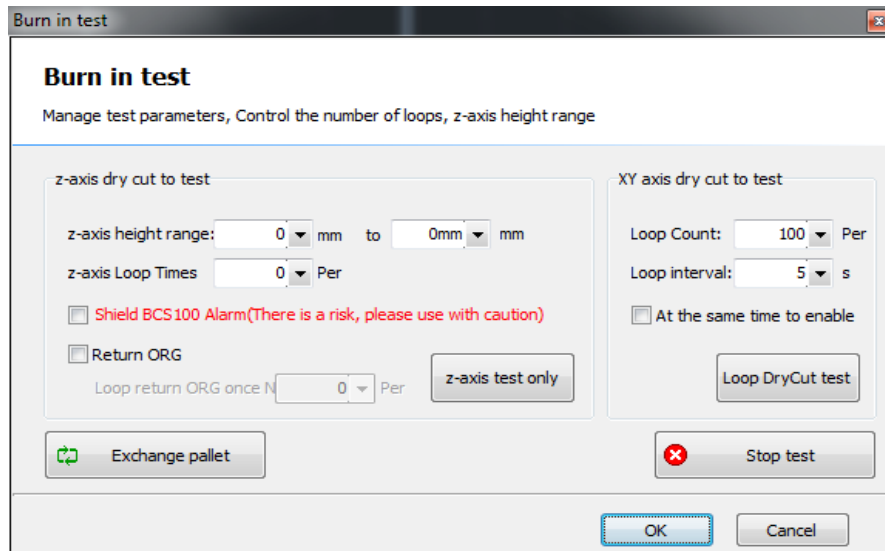

The actions to test the machine listed below:

- ❑ XY axis running on machine bed in full range at different speed in 2-48 hours to verify the reliable performance of motor function.
- ❑ Z axis continuously lifts up and down to test the stability of motor function. Execute return origin multiple times to verify the limit switch reliability.
- ❑ Z axis motion test without laser head axis moves between A to B position, it has to shield the capacitance alarm.



- ❑ Z axis motion test with laser head: Z axis moves between A to B position.

Do not shield BCS100 capacitance alarm, this is a protection for laser head collision.

- ❑ Z/XY motion test executed at same time.